

# SEISMIC PERFORMANCE EVALUATION CHARTS FOR GRAVITY TYPE QUAY WALLS

Koji ICHII<sup>1</sup>, Susumu IAI<sup>2</sup>, Yukihiro SATO<sup>3</sup> and Hanlong LIU<sup>4</sup>

<sup>1</sup>Member of JSCE, M.Eng., Researcher, Port and Airport Research Institute  
(Nagase 3-1-1, Yokosuka 239-0826, Japan)

<sup>2</sup> Member of JSCE, Dr. Eng., Director for Special Research (Disaster Prevention), Port and Airport Research Institute (Nagase 3-1-1, Yokosuka 239-0826, Japan)

<sup>3</sup> Member of JSCE, Engineer, Akita Port Construction Office, Ministry of Land, Infrastructure and Transport  
(Tuchizaki-kou nishi 1-1-49, Akita 011-0945, Japan)

<sup>4</sup> Director, Ph. D., Research Institute of Geotechnical Engineering, Hohai University, China  
(1 Xikang Road, Nanjing 210098, China)

More than two hundred cases of effective stress analyses with variation of seismic coefficients and liquefaction resistance were conducted. Among the parameters considered in this study, the most sensitive parameter affecting the wall displacement under a prescribed level of shaking is the SPT N-value of subsoil below and behind the wall. With the results of parametric calculations, a simple procedure and charts are proposed to evaluate the order-of-magnitude displacement of a quay wall. It demonstrated the capability to evaluate a wide range of displacements, ranging from the displacement in the order of tenths of meters to those with one order higher.

*Key Words: quay wall, liquefaction, deformation, seismic coefficient, seismic performance*

## 1. INTRODUCTION

The applicability of the effective stress analysis method for seismic performance evaluation of gravity type quay walls was verified with case histories of damage to quay walls in Kobe Port during the 1995 Kobe earthquake<sup>1), 2)</sup>. However, it is difficult to conduct effective stress analyses for all varieties of quay walls, which may be considered during the design procedure due to the limitation of costs and time. Therefore, it is desirable to establish a simple estimation technique for deformation of quay walls.

For gravity type quay walls, the relation between seismic coefficient and the level of input motion to cause the damage to quay walls are discovered based on the case histories<sup>3)</sup>. Furthermore, simplified damage evaluation technique using seismic coefficient are developed<sup>4)</sup>. However, this method is only applicable to the cases without liquefaction, and it is difficult to take it into account the effect of subsoil conditions below and behind quay walls.

To overcome this problem, a seismic performance evaluation charts for level-1 earthquake is

proposed based on parametric studies using effective stress analysis<sup>5)</sup>. In this paper, more comprehensive parametric study using effective stress analysis is performed, varying geotechnical and structural parameters for a gravity type quay wall under various levels of seismic excitations, to establish a simple estimation technique for deformation of gravity type quay walls. More than two hundreds cases of effective stress analyses with variations of seismic coefficients and liquefaction resistance were conducted. This parametric study aims to achieve two objectives. One is to identify major parameters governing the seismic performance of a gravity type quay wall. The other is to develop a simplified procedure for evaluating order-of-magnitude displacement of a gravity type quay wall.

## 2. SEISMIC PERFORMANCE OF GRAVITY TYPE QUAY WALLS

Gravity type quay walls are made of a concrete caisson or other retaining structures placed on a foundation, sustaining earth pressures from backfill

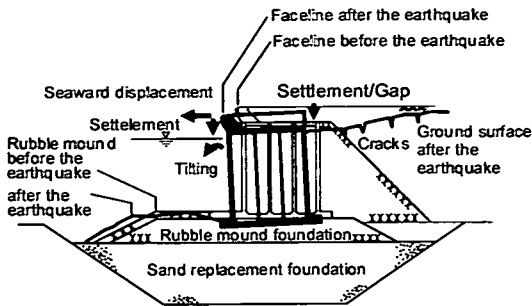

Fig.1 A typical failure mode of a gravity type quay wall due to the earthquake

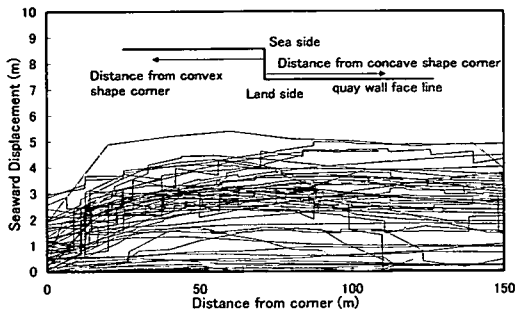

Fig.2 Seaward displacements of quay walls

soil behind the wall. For this type of quay walls, a typical failure mode due to earthquake is a seaward displacement and tilting of the walls as shown in Figure 1. It depends on the foundation characteristics whether the damage involves overall deformation of the foundation beneath the wall; i.e., a wall on a loose sandy foundation involves the deformation of the foundation and results in a large seaward displacement. Due to the seaward displacement of the caisson or retaining wall, settlements and cracks occur at the apron behind the wall.

Seismic performance of a gravity type quay wall can be specified in terms of serviceability. And the serviceability of a quay wall depends on many factors, such as its displacements, settlements, tilting, differential displacements along the face line of the wall, settlements at apron and gaps between apron and the wall. However, many of these factors can be correlated and it is not necessary to consider above all factors at the first step of the seismic performance evaluation. Therefore, the seaward displacement at the top of the wall is selected as the damage criteria for gravity type quay walls in this paper.

The uniformity of seaward displacements at the

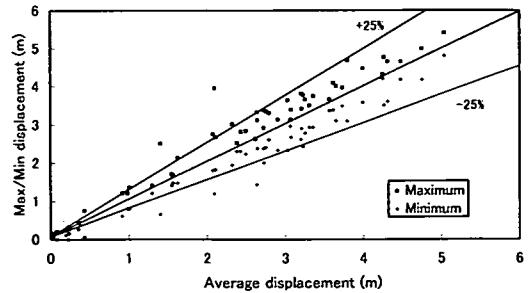

Fig.3 Uniformity of observed displacement (m)

top of walls are examined. Figure 2 shows the observed displacement of 58 case histories in Kobe port (Port island and Rokko Island)<sup>6)</sup> and Kushiro Port<sup>7)</sup>. Observed displacements are plotted based on the distance from the corner of quay wall face lines. No matter convex shape corner or concave shape corner, the displacements at the corner are smaller than that of the flat part. In average, the effects of corners are observed in the range of 50m from the corner. One of the mechanism of this phenomena for the convex corner case can be explained as the effect of lateral spread, since the significant lateral displacement was observed within 50m distance behind quay wall in Kobe case<sup>8)</sup>. For the flat part more than 50m far from a corner, observed displacements are relatively uniform. Based on Figure 3, most of the observed maximum and minimum displacements are within  $\pm 25\%$  from the average of observed displacements. Therefore, we can conclude that seaward displacements at the top of the walls are enough uniform to be a damage criteria if we choose average values of displacements of the area more than 50m far from its corner. Furthermore, these results suggest that the plane strain condition can be applied in the analyses as a reasonable assumption.

### 3. OUTLINE OF THE EFFECTIVE STRESS ANALYSIS METHOD

#### (1) Constitutive Equations

The constitutive model used in this study is a strain space plasticity type and consists of a multiple shear mechanism in the plane strain condition<sup>9)</sup>. With the effective stress and strain vectors written by

$$\{\sigma'\}^T = \{\sigma'_x, \sigma'_y, \tau'_{xy}\} \quad (1)$$

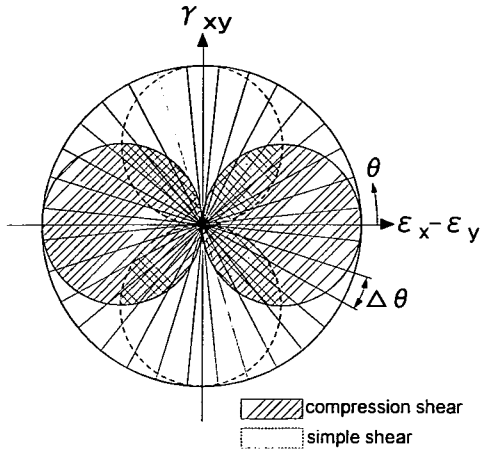

Fig.4 Schematic figure for the multiple simple shear mechanism

$$\{\epsilon\}^T = \{\epsilon_x, \epsilon_y, \gamma_{xy}\} \quad (2)$$

the basic form of the constitutive relation is given by

$$\{d\sigma'\} = [D](\{d\epsilon\} - \{d\epsilon_p\}) \quad (3)$$

in which

$$[D] = K \{n^{(0)}\} \{n^{(0)}\}^T + \sum_{i=1}^I R_{L/U}^{(i)} \{n^{(i)}\} \{n^{(i)}\}^T \quad (4)$$

In this relation, the term  $\{d\epsilon_p\}$  in Eq.(3) represents the additional strain incremental vector to take the dilatancy into account and is given from the volumetric strain increment due to the dilatancy as

$$\{d\epsilon_p\}^T = \{d\epsilon_p / 2, d\epsilon_p / 2, 0\} \quad (5)$$

The first term in Eq.(4) represents the volumetric mechanism with rebound modulus  $K$  and the direction vector is given by

$$\{n^{(0)}\}^T = \{1, 1, 0\} \quad (6)$$

The second term in Eq.(4) represents the multiple shear mechanism. Each mechanism  $i = 1, 2, \dots, I$  represents a virtual simple shear mechanism, with each simple shear plane oriented at an angle  $\theta_i / 2 + \pi / 4$  relative to the  $x$  axis.

The tangential shear modulus  $R_{L/U}^{(i)}$  represents the hyperbolic stress strain relationship with hysteresis characteristics. The direction vectors for the multiple shear mechanism in Eq.(4) are given by

Table 1 Parameters for the present constitutive model

Parameters	Type of Mechanism	Kind of the parameters
$K_{ma}$	Elastic Volumetric	Rebound modulus
$G_{ma}$	Elastic Shear	Shear modulus
$\phi_f$	Plastic Shear	Shear resistance angle
$\phi_p$	Plastic dilatancy	Phase transformation angle
$H_m$	Plastic shear	Hysteretic damping factor at large shear strain level
$p_1$	Plastic dilatancy	Initial phase of dilatancy
$p_2$	Plastic dilatancy	Final phase of dilatancy
$w_1$	Plastic dilatancy	Overall dilatancy
$S_1$	Plastic dilatancy	Ultimate limit of dilatancy
$c_1$	Plastic dilatancy	Threshold limit of dilatancy

$$\{n^{(i)}\}^T = \{\cos \theta_i, -\cos \theta_i, \sin \theta_i\} \quad (7)$$

(for  $i=1, 2, \dots, I$ )

in which

$$\theta_i = (i-1)\Delta\theta \quad (\text{for } i=1, 2, \dots, I) \quad (8)$$

$$\Delta\theta = \pi / I \quad (9)$$

A schematic figure for the multiple simple shear mechanism is shown in **Figure 4**. Pairs of circles indicate mobilized virtual shear strain in positive and negative modes of compression shear (solid lines with dark hatching) and simple shear (broken lines without hatching).

The loading and unloading for the shear mechanism are separately defined for each virtual simple shear mechanism by the sign of  $\{n^{(i)}\}^T \{d\epsilon\}$ . The multiple shear mechanism takes into account the effect of rotation of the principal stress axis directions, the effect of which is known to play an important role in the cyclic behavior of anisotropically consolidated sand<sup>(10)</sup>.

The volumetric strain increment due to the dilatancy in Eq.(5) is given as the function of plastic shear work. At each stage of deformation process under transient and cyclic loads, increment in plastic shear work is computed. The volumetric strain increment is given from the state parameter, which is based on cumulated plastic shear work. Ten parameters are needed for the present model: two of

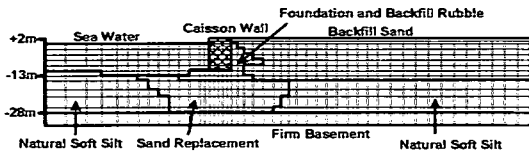

(a) An example of FEM Mesh and Material Configuration

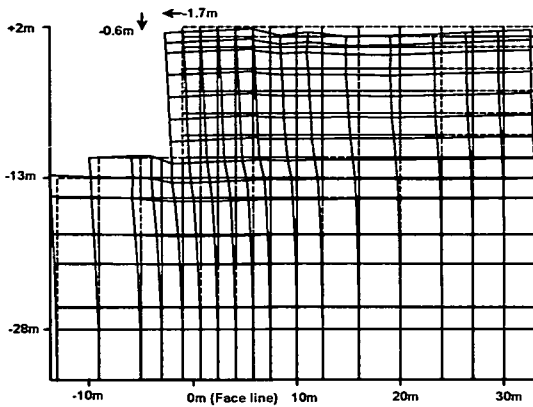

(b) An example of deformation around caisson wall

Fig.5 An example of FEM mesh ( $W/H=0.65$ ,  $D1/H=1.0$ )

which characterize elastic properties of soil, other two specify plastic shear behavior, and the rest characterize dilatancy, as shown in Table 1.

## (2) Finite element modeling

The finite element method was used for the analyses under the plane strain conditions. An example of FEM mesh before and after the deformation is shown in Figure 5. Four types of elements were used in the analyses: linear elements for the caisson, nonlinear elements for sand and clay, liquid elements for the sea water, and joint elements for the boundaries between soil and structure. The sea water was modeled as an incompressible fluid and formulated as an added mass matrix based on the equilibrium and continuity of fluid at the solid-fluid interface<sup>11</sup>. Before the earthquake response analyses, a static analysis was performed with the gravity under drained conditions to simulate the stress conditions before the earthquake. The results of the static analysis were used for the initial conditions in the earthquake response analyses. The seismic analyses were performed under undrained conditions to approximate the behavior of saturated soils under transient and cyclic loads during the earthquake. The input earthquake motion was specified at the bottom boundary through equivalent viscous dampers to simulate an incident transmitting wave (i.e. 2E). In order to simulate the in-

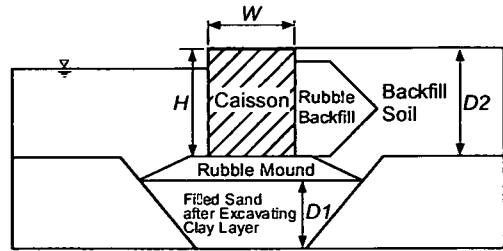

Fig.6 Typical cross section of a gravity type quay wall for parametric study

coming and outgoing waves through the side boundaries of the analysis domain, equivalent viscous dampers were also used at the boundaries. The effect of the free field motions was also taken into account by performing one dimensional response analysis at the outside fields and assigning the free field motion through the viscous dampers.

The computer program code named FLIP (Finite element analysis of Liquefaction Program) was used in this paper<sup>9</sup>. This is the same computer code used in the previous studies to verify the applicability of effective stress analysis method for the seismic performance evaluation of gravity type quay walls<sup>1), 2)</sup>.

## (3) Parameters characterizing gravity quay wall

The factors governing seismic performance of a gravity type quay wall include wall dimensions, the thickness of soil deposit below the wall, and liquefaction resistances of subsoil below and behind the wall, as well as the levels of seismic shaking at the base layer. In this study, the soil deposit below the wall was represented by a sand backfill used for replacing the original soft clay deposit in order to attain the required bearing capacity. The effects of this soil deposit on the deformation of a gravity type quay wall may be approximately the same as those of a natural sand deposit below the wall; thus, the results of the parametric study may be applicable not only for a quay wall with sand replacement studied here but also for a quay wall constructed on a natural sand deposit.

The standard cross section used for the parametric study is shown in Figure 6. Major cross sectional dimensions were specified by the width ( $W$ ) and the height ( $H$ ) of a gravity wall, and the thickness of subsoil ( $D1$ ). For simplicity, the thickness of backfill ( $D2$ ) was assumed the same as the wall height ( $H$ ). A width to height ratio of a gravity wall ( $W/H$ ) is one of the most important parameters in the conventional seismic design and correlated with

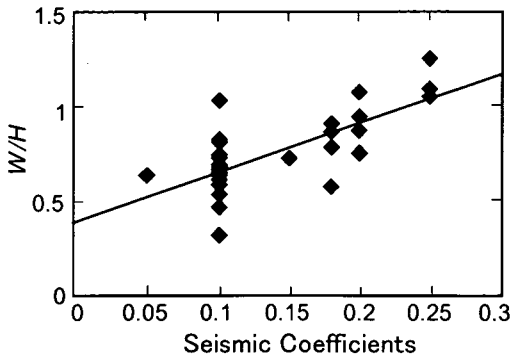

Fig.7 Correlation between the width to height ratio ( $W/H$ ) and seismic coefficients of a gravity type quay wall

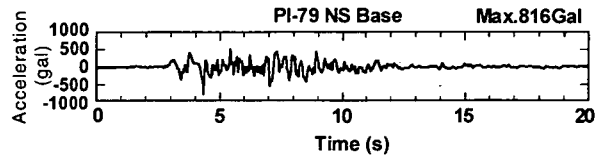

Fig.8 Time history used as input excitation (2E)

Table 2 Geotechnical model parameters

Equivalent SPT N values	$K_{ma}$ (kPa)	$G_{ma}$ (kPa)	$\sigma'_{ma}$ (kPa)	$\phi_f$ (degree)	$\phi_p$ (degree)	$H_m$ (%)	$p_1$	$p_2$	$w_1$	$S_1$	$c_1$	$D_r$ (%)
5	146000	56100	98.0	39.0	28.0	24	0.5	1.12	1.15	0.005	1.6	41
8	191000	73380	98.0	39.6	28.0	24	0.5	1.06	3.76	0.005	1.6	48
10	221000	84900	98.0	40.0	28.0	24	0.5	1.02	5.5	0.005	1.3	55
15	281000	108000	98.0	41.0	28.0	24	0.5	0.92	9.2	0.005	1.3	66
20	345000	132000	98.0	42.0	28.0	24	0.5	0.8	23.5	0.005	1.0	77
25	396000	152000	98.0	42.0	28.0	24	0.5	0.7	50.0	0.005	1.0	85

the seismic coefficients used in the pseudo-static method as shown in Figure 7, which is based on Japanese case histories. The width to height ratio ( $W/H$ ) was thus considered as a major parameter in this study. The parameters used in this study were  $W/H=0.65, 0.90, 1.05$ , which correspond to the seismic coefficients of  $K_r=0.1, 0.2, 0.25$ , respectively.

The peak accelerations of the input seismic excitation assigned at the base layer as the incident wave (as of 2E) ranged from 0.1 to 0.6 g. The time history of the earthquake excitation was that of the incident wave (2E) at the Port Island (Kobe) vertical seismic array site at a depth of -79m. This time history, shown in Figure 8, is often used in Japan for evaluating seismic performance of high earthquake resistant quay walls under Level 2 earthquake motions<sup>12</sup>.

The thickness of the soil deposit below the wall ( $DI$ ) was specified by a ratio with respect to the wall height ( $H$ ), ranging from  $DI/H=0.0$  (i.e. a rigid base layer located immediately below the wall) to  $DI/H=1.0$  (i.e. thick soil deposit below the wall).

Other geometrical conditions assumed for the ef-

fective stress analyses include; wall height  $H=13m$ , water level=2m lower than the top of the wall, thickness of the rubble mound=4m.

#### (4) Geotechnical conditions and parameters

For simplicity, the geotechnical conditions of the soil deposits below and behind the wall were assumed to be the same with each other, represented by the equivalent SPT N-value (the corrected SPT N-value for the effective vertical stress of 65 kPa in terms of a equivalent relative density<sup>13</sup>). The equivalent SPT N-value has been widely used for the assessment of liquefaction potential in Japanese port areas<sup>14</sup>. Model parameters for the effective stress analyses were determined by the equivalent SPT N-values based on a simplified procedure<sup>15</sup>.

The geotechnical model parameters determined by the equivalent SPT N values are summarized in Table 2. Two parameters,  $K_{ma}$  and  $G_{ma}$ , for elastic properties are given at the condition of the reference mean confining pressure,  $\sigma'_{ma}$ , and the rebound modulus,  $K$ , and the shear modulus,  $G$ , at the site are given by power functions of the effective mean stress,  $\sigma'_m$ .

$$K = K_{ma} (\sigma'_m / \sigma'_{ma})^{0.5} \quad (10)$$

$$G = G_{ma} (\sigma'_m / \sigma'_{ma})^{0.5} \quad (11)$$

The assumed relative density,  $D_r$ , for each equivalent SPT N values, which were given in the process of the simplified procedure<sup>15</sup>, are also shown in Table 2 as references.

#### 4. PARAMETER SENSITIVITY ON QUAY WALL DISPLACEMENT

The results of the parametric study were summarized in terms of the residual horizontal displacement ( $d$ ) at the top of the wall. The residual horizontal displacement was normalized with respect to the wall height ( $H$ ). The effects of the major parameters on the normalized residual horizontal displacement ( $d/H$ ) will be discussed below.

##### Width to Height Ratio ( $W/H$ )

The effects of width to height ratio ( $W/H$ ) on the displacement are shown in Figure 9 for the equivalent SPT N-value of 15. When the foundation below the wall is rigid (i.e.  $D1/H=0$ ), increasing  $W/H$  reduces the wall displacement. When the foundation soil is medium to dense (i.e. with the equivalent SPT N-values of 15) and thick (i.e.  $D1/H=1.0$ ), however, the effects of  $W/H$  become less obvious.

##### Input Excitation Level

The effects of input excitation level are shown in Figure 10 for  $W/H=0.9$ , which corresponds to the seismic coefficient of  $k_h=0.2$  (see Figure 7). Except for the equivalent SPT N-values of 5 and 8, at which extensive liquefaction significantly increases the displacement, the normalized displacements for the excitation of 0.2 g at the base layer are within  $d/H < 0.03$ . The horizontal displacement of a wall for  $d/H=0.03$  is, for example, 0.3 m for a gravity quay wall with  $H=10$  m, suggesting that the quay wall designed with the seismic coefficient of 0.2 based on the conventional pseudo-static method withstands the excitation of 0.2 g at the base layer if a margin of displacement in the order of 0.3 m is allowed.

##### Equivalent SPT N-value

The effects of the equivalent SPT N-value are shown in Figure 11 for  $W/H=0.9$ . Obviously the thickness of soil deposit below the wall significantly affects the displacement. For a wall put on a rigid foundation ( $D1/H=0$ ), the effects of the equivalent SPT N-value of soil behind the wall are

relatively small. For a wall put on a thick soil deposit ( $D1/H=1.0$ ), the effects of the equivalent SPT N-values of soil below and behind the wall are significant.

##### Thickness of Soil Deposit below Wall

The effects of the thickness of soil deposit below the wall are shown in Figure 12 for  $W/H=0.9$ . When the level of excitation is high, significant increase in the displacement is recognized for  $D1/H < 0.5$  and for smaller SPT N-values, suggesting that the existence of soil deposit below the wall and its SPT N-values are two important factors to affect the displacement.

##### Overall Parameter Sensitivity

Among the parameters considered in this study, the most sensitive parameter affecting the quay wall displacement under a prescribed level of shaking is the SPT N-values of subsoil below and behind the wall. The second is the thickness of the soil deposit below the wall. Although the width to height ratio of a gravity wall is a sensitive parameter for a quay wall with a firm foundation, the effects of this parameter become less obvious when the soil deposit below the wall is thick.

However, the parametric study above is for a quay wall with  $H=13$ m and the scale effect of its results are not examined yet. Furthermore, to reduce cases, only three cases are conducted to draw each line in Figure 9 and 12. Therefore, the results are less accurate than Figure 10 and 11. These points are remained for future studies to improve the accuracy.

#### 5. PROCEDURES FOR EVALUATING WALL DISPLACEMENT

As mentioned earlier, the effective stress analysis is particularly useful for identifying deformation / failure modes and evaluating the limit-state performance of quay walls and bulkheads. The effective stress analysis, however, requires a high level of engineering and reasonable amount of resources; hence, it is not always easy to apply for the routine design practice. A simplified procedure is necessary for evaluating order-of-magnitude displacement in the routine design practice.

Although the Newmark type analysis is often adopted as a simplified procedure to evaluate the earthquake induced displacement, the Newmark type analysis often underestimates the displacement of those retaining structures with submerged

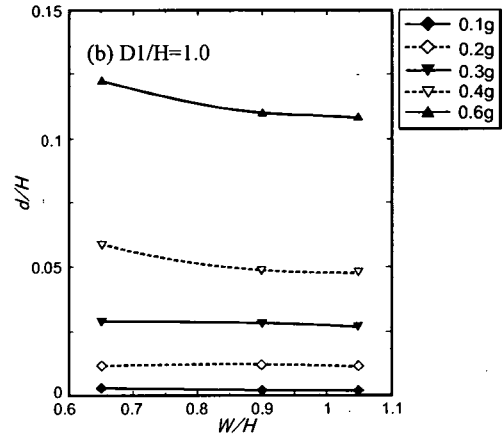
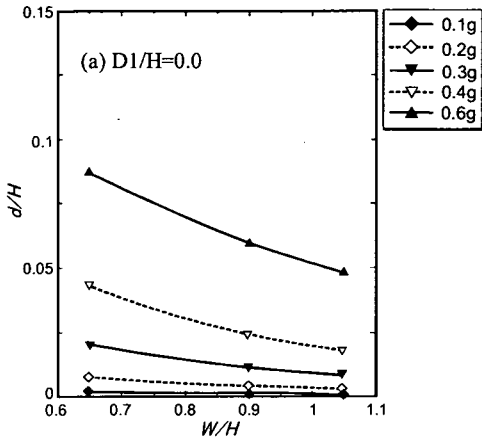

Fig.9 Effects of the width to height ratio  $W/H$  (for equivalent SPT N-value of 15)

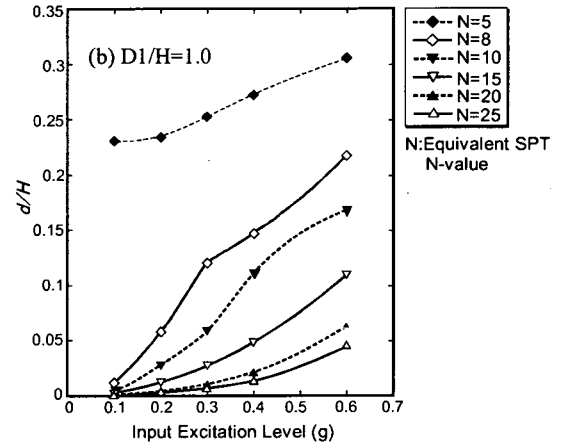
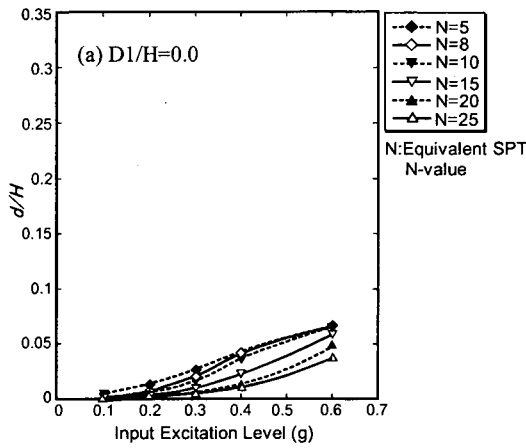

Fig.10 Effects of the input excitation level (for  $W/H=0.9$ )

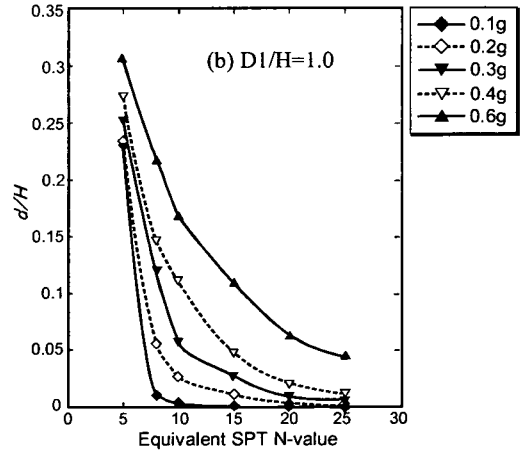
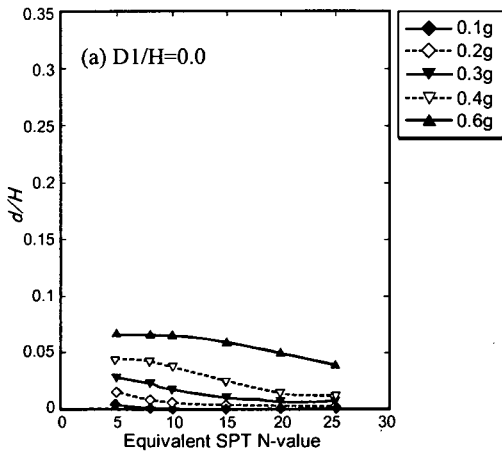

Fig.11 Effects of the equivalent SPT N-value (for  $W/H=0.9$ )

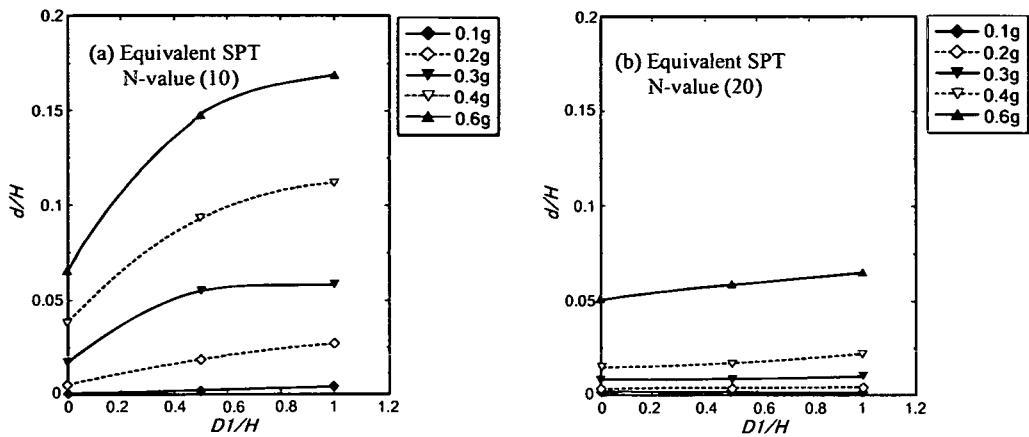

Fig.12 Effects of the thickness of soil deposit below the wall (for  $W/H=0.9$ )

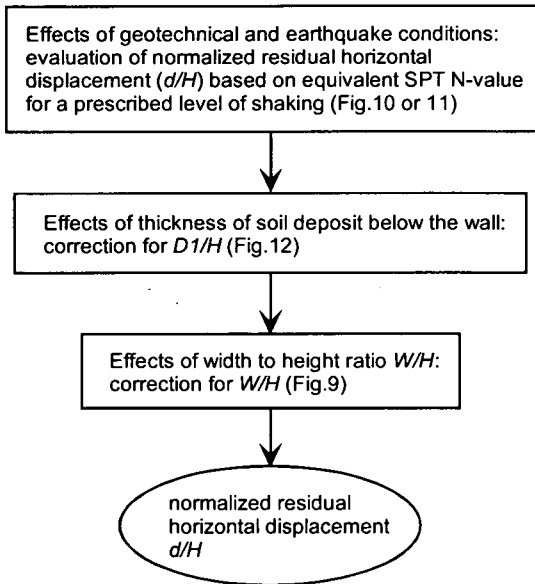

Fig.13 Procedures to evaluate the quay wall displacement

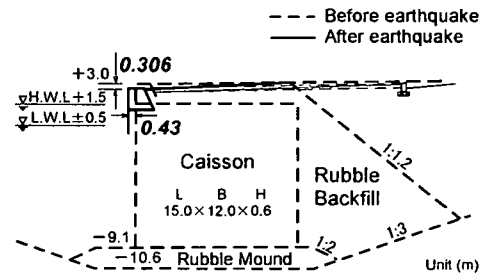

Fig.14 Cross section and deformation of a quay wall at Kushiro Port (West Port District No.2 West quay wall -9m)

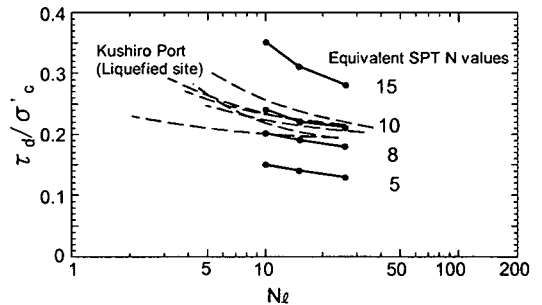

Fig.15 Liquefaction resistance in Kushiro Port

backfill<sup>16</sup>). A new procedure is necessary to include the cyclic behavior of saturated soil below and behind the wall in evaluating the quay wall displacement. The results of the parametric study obtained in the previous chapter offer a basis to meet this need.

Based on the results of the parametric study shown in the previous chapter, a simple procedure is easily developed for evaluating the displacement of gravity type quay walls. The flow chart for the

simplified procedure is shown in **Figure 13**. In this procedure, the displacement is evaluated with respect to the parameters in the order of its sensitivity to the displacement. First of all, rough estimation is given by **Figure 10** or **11**. Since these two figures are showing identical results just in different manner, whichever easy to read can be applied. Then, the correction for  $D1/H$  is applied based on **Figure 12**. Finally, the estimation is given after the correction for  $W/H$  based on **Figure 9**.



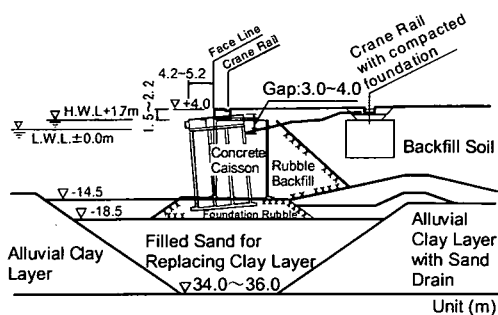

Fig.16 Cross section and deformation of a quay wall at Kobe Port (RC-5, Rokko Island -14m)

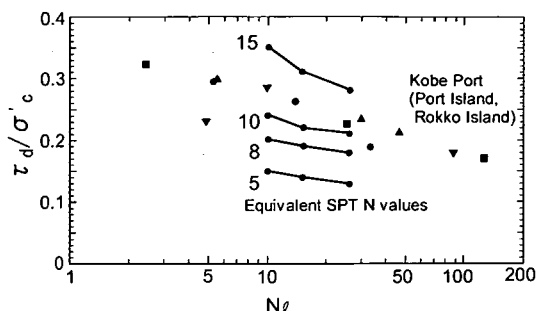

Fig.17 Liquefaction resistance in Kobe Port

Table 3 Simplified evaluation of residual horizontal displacements

Case Histories		
Case History	Kushiro Port, West Port District The 1993 Kushiro-oki earthquake	Kobe Port, Rokko Island The 1995 Hyogoken-Nambu earthquake
Measured horizontal displacement at the earthquake ( $d/H$ )	$d/H=0$ to 0.04 <i>on the average <math>d/H=0.02</math></i>	$d/H=0.1$ to 0.3 <i>on the average <math>d/H=0.2</math></i>
Simplified Evaluation		
Input excitation level	0.27 g recorded at -79m at the vertical seismic array site To be rounded to 0.3 g in simplified evaluation	0.55 g recorded at -32m at the vertical seismic array site To be rounded to 0.6 g in simplified evaluation
Equivalent SPT N-value	Equivalent SPT N-value about 8 to 10 $d/H=0.018$ to 0.022	Equivalent SPT N-value about 10 $d/H=0.17$
$D1/H$	$D1/H=0$ No correction needed for $D1/H$	$D1/H=1.0$ No correction needed for $D1/H$
$W/H$	$W/H=1.04$ to 1.09 Correction factor of 0.7 to 0.8 is needed for $W/H=0.9$	$W/H=0.64$ to 0.74 Correction factor of 1.1 is needed for $W/H=0.9$
Normalized horizontal displacement based on simplified procedure ( $d/H$ )	$d/H=0.013$ to 0.018 <i>To be rounded to <math>d/H=0.01 \sim 0.02</math></i>	$d/H=0.19$ <i>To be rounded to <math>d/H=0.2</math></i>

However, the scale effect are not examined yet as mentioned above. Thus, the applicability of Figure 9 to 12 might be only valid for the quay wall with large water depth (i.e.  $H=$  approx. 13m).

Then, the overall applicability of the proposed procedure was evaluated based on the case history data. Two case histories were explained here in detail. One was the quay wall performance at Kushiro Port during the 1993 Kushiro-oki earthquake. The cross section of the gravity quay wall is shown in Figure 14. As shown in this figure, a caisson wall was put on a firm foundation with the SPT N-values ranging from 30 to 50, with a loose backfill. The equivalent SPT N-values of backfill are about 8 to 10, since the measured liquefaction resistance

for the backfill are in between those of equivalent SPT N-values of about 8 to 10, as shown in Figure 15<sup>17)</sup>. The liquefaction resistance curves for equivalent SPT N-values 5 to 15 shown in Figure 15 and 17 are given in the simplified procedures to calibrate input parameters<sup>13)</sup>. Shaken with a peak bed-rock acceleration of 0.27g (EW)<sup>17)</sup>, the residual displacement of the caisson wall at the site ranged from  $d/H=0.0$  to 0.04, on the average  $d/H=0.02$ <sup>7)</sup>.

The other was the quay wall performance at Kobe Port during the 1995 Hyogoken-Nambu earthquake. The cross section of the gravity quay wall is shown in Figure 16<sup>8)</sup>. As shown in this figure, a caisson wall was put on a loosely deposited decomposed granite. The equivalent SPT N-values

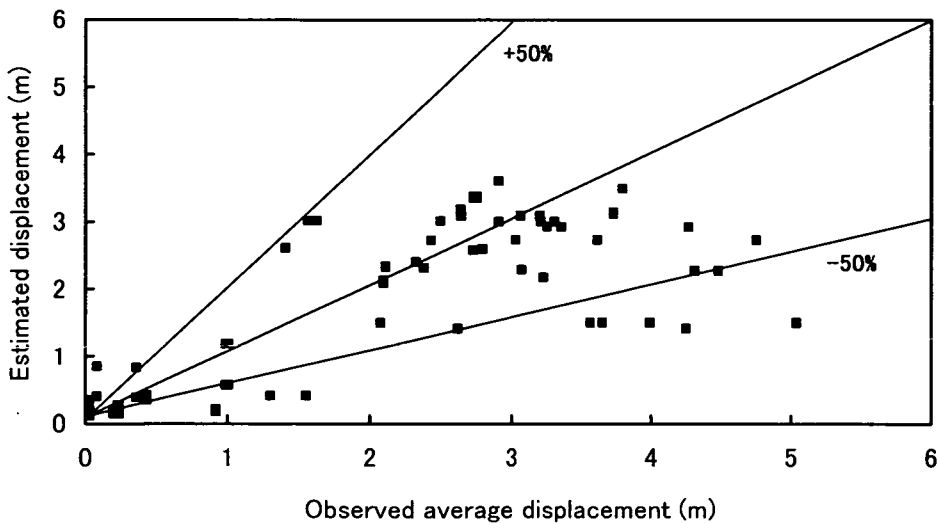

Fig.18 Verification of proposed charts

for subsoil below and behind the wall were 10 on the average, since its liquefaction resistance are similar to that of equivalent SPT N-values about 10, as shown in **Figure 17**<sup>8)</sup>. Shaken with a peak acceleration of 0.55g (NS) at a depth of GL-32m, as recorded at the Port Island vertical seismic array site<sup>18)</sup>, the residual displacement of the caisson walls having the sand deposit of  $D/H=1.0$  (for  $D$  ranging from 15 to 20m) ranged from  $d/H=0.10$  to 0.30, on the average  $d/H=0.20$ <sup>8)</sup>.

The order-of-magnitude displacements of gravity quay walls were evaluated based on the major parameters relevant to these two case histories. The results are shown in **Table 3**. They are basically consistent with those measured, suggesting reasonable applicability of the simplified procedure.

Same procedures are adopted on the 55 case histories of large scale gravity type quay walls ( $H>7$ m) on Kobe port and Kushiro port. The parameters in case histories are in the range of  $H$ : 7 ~ 19.8m,  $W$ : 4 ~ 15.3m and  $D$ : 0 ~ 20m ( $W/H$ : 0.56 ~ 1.11,  $D/H$ : 0 ~ 1.91). Due to the limited information, equivalent SPT N-values and input excitation levels at the site are identical with aforementioned cases. Although the results of evaluated deformation are scattering due to rough estimation of input parameter, as shown in **Figure 18**, the estimated displacements are not far different from the observed displacements in most cases. Though some cases show more than twice of observed dis-

placement, and other some cases show less than half of observed displacement, it might be due to the inaccurate information of input excitation level or geotechnical conditions at the site. Therefore, these problem can be solved in future study to improve the accuracy of the procedures. Thus, it can be concluded that the simplified procedure demonstrated the capability to evaluate wide range of displacements, ranging from the displacement in the order of one-tenths of meters to those with one order higher.

## 6. CONCLUSION

Seismic performance of gravity type quay walls was studied through the effective stress analyses by varying structural and geotechnical parameters under various levels of shakings. Major conclusions obtained from this parametric study are as follows.

(1) Among the parameters considered in this study, the most sensitive parameter affecting the quay wall displacement under a prescribed level of shaking is the SPT N-values of subsoil below and behind the wall. The second is the thickness of the soil deposit below the wall. Although the width to height ratio of the gravity wall is a sensitive parameter for the quay wall with a firm foundation, the effect of this parameter becomes less obvious when the soil deposit below the wall becomes thick.

(2) A simple procedure is proposed to evaluate the order-of-magnitude displacement of a gravity type quay wall. In this procedure, the residual horizontal wall displacement under a prescribed level of shaking is evaluated based on the three parameters mentioned above.

(3) The applicability of the proposed simplified procedure was confirmed by case history data. The procedure demonstrated the capability to evaluate a wide range of displacements, ranging from the displacement in the order of one-tenths of meters to those with one order higher.

## REFERENCES

- 1) Iai, S., Ichii, K., Liu, H. and Morita, T.: Effective stress analyses of port structures, *Special Issue of Soils and Foundations*, Japanese Geotechnical Society, pp.97-114, 1998.
- 2) Ichii, K., Iai, S. and Morita, T.: Performance of the quay wall with high seismic resistance, *Structural Eng. / Earthquake Eng.*, JSCE, Vol. 17, No. 2, pp.163s-174s, 2000.
- 3) Noda, S., Uwabe, T. and Chiba, T.: Relation between seismic coefficient and ground acceleration for gravity quay wall, *Report of the Port and Harbour Research Institute*, Vol. 14, No. 4, pp.67-111 (in Japanese), 1975.
- 4) Uwabe, T.: Estimation of Earthquake damage deformation and cost of quaywalls based on earthquake damage records, *Technical note of the Port and Harbour Research Institute*, No. 473, (in Japanese), 1983.
- 5) Coastal Development Institute of Technology: *A proposal of the guideline for simplified seismic performance verification for gravity type quay walls* (in Japanese), 1999.
- 6) Inatomi, T., Zen, K., Toyama, S., Uwabe, T., Iai, S., Sugano, T., Terauchi, K., Yokota, H., Fujimoto, K., Tanaka, S., Yamazaki, H., Koizumi, T., Nagao, T., Nozu, A., Miyata, M., Ichii, K., Morita, T., Minami, K., Oikawa, K., Matsunaga, Y., Ishii, M., Sugiyama, M., Takasaki, N., Kobayashi, N. and Okashita, K.: Damage to port and port-related facilities by the 1995 Hyogoken-nanbu earthquake, *Technical note of the Port and Harbour Research Institute*, No. 857 (in Japanese), 1997.
- 7) Ueda, S., Inatomi, T., Uwabe, T., Iai, S., Kazama, M., Matsunaga, Y., Hujimoto, T., Kikuchi, Y., Miyai, S., Sekiguchi, S. and Hujimoto, Y.: Damage to port structures by the 1993 Kushiro-oki earthquake, *Technical note of the Port and Harbour Research Institute*, No. 766 (in Japanese), 1993.
- 8) Ishihara, K., Yasuda, S. and Nagase, H.: Soil characteristics and ground damage, *Special Issue of Soils and Foundations*, Japanese Geotechnical Society, pp.109-118, 1996.
- 9) Iai, S., Matsunaga, Y. and Kameoka, T.: Strain space plasticity model for cyclic mobility, *Soils and Foundations*, Vol. 32, No. 2, pp.1-15, 1992a.
- 10) Iai, S., Matsunaga, Y. and Kameoka, T.: Analysis of cyclic behavior of anisotropically consolidated sand, *Soils and Foundations*, Vol. 32, No. 2, pp.16-20, 1992b.
- 11) Zienkiewicz, O.C.: *The Finite Element Method*, 4th edition, McGraw-Hill Book Co, vol. II, pp.407-419, 1977.
- 12) Ministry of Transport: *Handbook on liquefaction remediation of reclaimed land*, New edition, Coastal Development Institute of Technology, Japan, 81 (in Japanese), 1997.
- 13) Port and Harbour Research Institute: *Handbook on liquefaction remediation of reclaimed land*, A.A.Balkema, Netherlands, 1997.
- 14) Iai, S., Tsuchida, H. and Koizumi, K.: A liquefaction criterion based on field performances around seismograph stations, *Soils and Foundations*, Vol. 29, No.2, pp.52-68, 1989.
- 15) Morita, T., Iai, S., Liu, H., Ichii, K. and Sato, Y.: Simplified method to determine parameter of FLIP, *Technical note of the Port and Harbour Research Institute*, No. 869 (in Japanese), 1997.
- 16) Iai, S.: Seismic analysis and performance of retaining structures, *Geotechnical Earthquake Engineering and Soil Dynamics III*, ASCE Geotechnical Special Publication, No.75, Vol.2, pp.1020-1044, 1998.
- 17) Iai, S., Morita, T., Kameoka, T., Matsunaga, Y. and Abiko, K.: Response of a dense sand deposit during the 1993 Kushiro-oki earthquake, *Soils and Foundations*, Vol. 35, No.1, pp.115-131, 1995.
- 18) Iwasaki, Y. and Tai, M.: Strong motion records at Kobe Port Island, *Special Issue of Soils and Foundations*, Japanese Geotechnical Society, pp.29-40, 1996.

(Received September 30, 2001)

## 重力式岸壁の耐震性能評価手法

一井康二・井合 進・佐藤幸博・劉 漢龍

重力式岸壁の簡易的な耐震性能の評価手法を検討するため、設計震度および地盤の液状化強度をパラメータとして、有効応力法による有限要素解析プログラムを用いて、200ケースを越えるパラメトリックスタディを行った。パラメトリックスタディの結果、岸壁の変位量には岸壁直下及び背後地盤の条件が最も影響を与えることが明らかになった。パラメトリックスタディの結果をもとに、重力式岸壁の変位量のレベルを推定する簡易的な耐震性能照査手法を提案した。また、被災事例のデータをもとに提案手法の適用性を検討し、数10cmから数m程度の幅広い変位レベルに対し一定の適用性を供えていることを確認した。