

# PARAMETRIC STUDY ON STEEL TOWER SEISMIC RESPONSE OF CABLE-STAYED BRIDGES UNDER GREAT EARTHQUAKE GROUND MOTION

Shehata E. ABDEL RAHEEM<sup>1</sup> and Toshiro HAYASHIKAWA<sup>2</sup>

<sup>1</sup>Graduate Student, Graduate School of Engineering, Hokkaido University  
(Nishi 8 Kita 13 Kita-ku, Sapporo 060-8628, Japan)

<sup>2</sup>Fellow of JSCE, Dr. of Eng., Assoc. Prof., Graduate School of Engineering, Hokkaido University  
(Nishi 8 Kita 13 Kita-ku, Sapporo 060-8628, Japan)

Analytical parametric study on dynamic characteristics of steel tower of cable-stayed bridges is performed to investigate the individual influence of different design aspects, such as damping mechanism, input ground motion, allowable initial construction imperfections, energy dissipation and tower modal shapes. The results show that the horizontal beam height and length and the low yield energy dissipation system significantly affect tower structural behavior. The initial imperfections within design range have slight detrimental effects on the tower seismic response but these effects grow rapidly beyond the design range. Mass proportional damping leads to overestimate tower axial forces and acceleration response.

*Key Words:* steel tower, cable-stayed bridge, energy dissipation, seismic design, imperfections

## 1. INTRODUCTION

In recent decades, long span bridges such as cable-stayed bridges have gained much popularity due to their aesthetic appearance, efficient utilization of structural materials, increase of the horizontal navigation clearances and the economic trade off of span length cost of deep water foundation. The trend nowadays for cable-stayed bridges is to use more shallow or slender stiffening girders combined with increasing span lengths. This structural synthesis provides a valuable environment for the nonlinear behavior due to material nonlinearities and geometrical nonlinearities of the relatively large deflection of the structure on the stresses and forces<sup>1) - 3)</sup>. The Hyogoken-Nanbu earthquake of 17th January 1995, led to an increased awareness concerning the response of highway bridges subjected to earthquake ground motions, the ductility design and dynamic analyses have been reconsidered by Japan Road Association<sup>4)</sup>. The necessity has arisen to develop more efficient analysis procedures that can lead to a through understanding and a realistic prediction of the precise three-dimensional nonlinear dynamic response of bridge structural systems to improve the bridges seismic performance, to provide damage control and post-earthquake functionality.

In the analysis and design of earthquake resistant structures, particularly bridge structures, the vertical ground motion tends, in general, to be

ignored or underestimated in seismic analysis. The current seismic codes recommend a vertical spectrum with values that vary from half to three quarters of that of the horizontal spectra. This approach seems to be un-conservative in light of ground motion measurements during recent earthquakes, which indicate that the vertical acceleration could reach values even higher than that of the horizontal acceleration. Moreover, in a near field region, the peak of vertical to horizontal spectral ratio is even larger than that of the peak ground acceleration, especially at short periods<sup>5)</sup>. Also field observations proved that many structures experienced significant damage attributable to high vertical forces<sup>6) - 8)</sup>. The dynamic analysis of bridge column and pier structures subjected to horizontal and vertical excitations was considered only recently by some researchers<sup>8), 9)</sup>, where the results of that analyses with the inelastic plane stress elements, displayed unstable hysteresis loops and little energy dissipation.

The strength and ductility of a thin-walled steel member are particularly sensitive to initial imperfections including geometric imperfection and longitudinal residual stresses. The initial imperfections of these structures that have not been subjected to damage usually result from the fabrication process. Some studies<sup>10) - 14)</sup> have been carried out on welded and hot rolled structures, it was reported that the detrimental effects of geometric imperfection and welding residual

stresses that led to an appreciable reduction in load carrying capacity. However, a study of the effect of initial imperfections on the dynamic behavior of thin-walled structures is not available in literature. Moreover, the dynamic response of steel tower depends to large extent on tower modal shapes<sup>15)</sup>, including the horizontal beam position and its elements relative strength. For economical earthquake resistant of steel tower and its protection from the earthquake hazard, the tower structure should be constructed to dissipate a large amount of input seismic energy that could be achieved by proper selection of tower shapes and its elements relative strength. The low strength steels with low yield stresses and large ductility have been introduced for the hysteretic damper concept; the energy dissipation of hysteretic dampers through their materials could be used for structure damage control under large earthquake excitations<sup>16)-18)</sup>.

A parametric study on steel tower of cable-stayed bridges is performed for investigation of the individual influence of different design aspects on tower dynamic characteristics. This study aims at clarifying the characteristics of the vertical ground motion and damping mechanism effects on critical seismic response quantities of the steel tower under strong ground motions. A comparison of the response with and without the vertical component is performed for two different cases of spectral damping schemes. It is confirmed from numerical results that the vertical excitation could have a detrimental effect on axial force and overestimated acceleration of tower seismic response for the mass proportional damping scheme, but slightly effects for Rayleigh's damping.

Moreover, this study investigates the steel tower seismic response under initial construction imperfections using finite element method. The amplitude of imperfections in the lowest eigenmodes of vibration is considered to be sufficient to characterize the influential imperfections<sup>19)</sup>. As a result, a great deal of insight has been obtained on the dynamic response of steel tower. The results indicate that both the initial geometric imperfection and the welding induced residual stresses within their design range slightly affect on the tower seismic response but beyond the design range, these effects are characterized by rapidly and nonlinearly growth as the initial imperfections approach severe values. The residual stress effects are due to decreasing plastic deformation capability, consequently promoting brittle behavior.

An effective energy dissipation concept is suggested by a typically concentration of inelastic behavior at tower horizontal beam using low

relative strength and stiffness, which can be achieved by inserting low yield material instead of cross section dimensions reduction. Since the horizontal beam is easy to inspect and repair if necessary, the rest of the structure will remain elastic, thus eliminating permanent damage and minimizing the extent of retrofit. The calculated results prove the effectiveness of the proposed energy dissipation system in reducing structural elements forces and control tower maximum displacement, and enable to determine the optimum position of horizontal beam for economical earthquake resistant design.

## 2. NONLINEAR DYNAMIC ANALYSIS PROCEDURES

The governing nonlinear dynamic equation of the tower response can be derived by the principle of energy that the external work is absorbed by the work of internal, inertial and damping for any small admissible motion that satisfies compatibility and boundary conditions. By assembling the element dynamic equilibrium equation for the time  $t + \Delta t$  over all the elements, the incremental FEM dynamic equilibrium equation<sup>1), 20)</sup> can be obtained as:

$$[\mathbf{M}]\{\ddot{u}\}^{t+\Delta t} + [\mathbf{C}]\{\dot{u}\}^{t+\Delta t} + [\mathbf{K}]^{t+\Delta t}\{\Delta u\}^{t+\Delta t} = \{\mathbf{F}\}^{t+\Delta t} - \{\mathbf{F}\} \quad (1)$$

where  $[\mathbf{M}]$ ,  $[\mathbf{C}]$  and  $[\mathbf{K}]^{t+\Delta t}$  are the system mass, damping and tangent stiffness matrices at time  $t + \Delta t$ , the tangent stiffness considers the material nonlinearities through bilinear elastic-plastic constitutive model incorporating a uniaxial yield criteria and kinematic strain hardening rule.  $\ddot{u}$ ,  $\dot{u}$  and  $\Delta u$  are the accelerations, velocities, and incremental displacements at time  $t + \Delta t$ , respectively,  $\{\mathbf{F}\}^{t+\Delta t} - \{\mathbf{F}\}^t$  is the unbalanced force vector. The dynamic equilibrium equation of motion considers both geometrical and material nonlinearities that affect the tangent stiffness and internal forces calculation.

In this study, the Newmark step-by-step integration method is used for the integration of equation of motion, since it has been experienced that the Newmark's  $\beta$  method is the most suitable for nonlinear analysis; it has the lowest period elongation and has no amplitude decay or amplifications. In addition, the stability concern is not a problem with the variable ratio of time increment to natural period. The algorithm is unconditionally stable if  $\beta \geq (\gamma + 0.5)^2/4$ . In this study, the Newmark's  $\beta$  of constant acceleration scheme for the solution of the differential equation

of motion is considered for which  $\beta$  is equal to 0.25, The second numerical parameter  $\gamma$  of Newmark's  $\beta$  method is set as  $\gamma = 0.5$  to avoid a superfluous damping in the system. The equation of motion is solved for the incremental displacement using the Newton-Raphson iteration method; the stiffness matrix is updated at each increment to consider the geometrical and material nonlinearities and to speed the convergence rate.

### 3. FINITE ELEMENT OUTLINE

#### (1) Finite element model

The steel tower of a three span continuous cable-stayed bridge located in Hokkaido, Japan is considered, in which the main span length is equal to 284m. The steel tower is taken out of the cable-stayed bridge and modeled as three-dimensional frame structure. A fiber flexural element is developed for characterization of the steel tower and that element incorporates both geometric and material nonlinearities. The Hermitian cubic displacement field is employed for the transverse bending displacements of the element and a linear displacement field is employed for the axial and torsional displacements. The stress-strain relationship of the beam element is modeled as bilinear stress strain relation for the beam column element. The yield stress and the modulus of elasticity are equal to 355 MPa (SM490Y) and 200GPa, respectively, the strain hardening in the plastic region is equal to 0.01.

Inelasticity of the fiber flexure element is accounted for by the division of the cross section into a number of fiber zones with uniaxial plasticity defining the normal stress-strain relationship for each zone, the element stress resultants are determined by integration of the fiber zone stresses over the cross section of the element. By tracking the center of the yield region, the evolution of the yield surface is monitored, and a stress update algorithm is implemented to allow accurate integration of the stress-strain constitutive law for strain increments, including full load reversals. To ensure path dependence of the solution, the implementation of the plasticity model for the implicit Newton-Raphson equilibrium iterations employs stress integration, whereby the element stresses are updated from the last fully converged equilibrium state. The transformation between element local and global coordinate systems is accomplished through a vector translation of element forces and displacements based on the direction cosines of the current updated element coordinate system.

The nonlinear behavior of cable elements is idealized by using the equivalent modulus approach, in this approach each cable is replaced by a truss element with equivalent tangential modulus of elasticity  $E_{eq}$  that is given by Ernst<sup>21)</sup> as:

$$E_{eq} = E / \{1 + EA (wL)^2 / 12T^3\} \quad (2)$$

where  $E$  is the material modulus of elasticity,  $L$  is the horizontal projected length of the cable,  $w$  is the cable weight per unit length,  $A$  is the cable cross sectional area and  $T$  is the cable pretension force. It can be noticed that the nonlinearity of the cable stays originates with an increase in the loading followed by a decrease in the cable sag as a consequence the apparent axial stiffness of the cable increases. The inclined cable is represented by an equivalent straight cable element with relative axial deformation ( $\Delta l$ ), the stiffness matrix of the cable element  $\mathbf{K}$  has the value equal to  $E_{eq}A/l$  for  $\Delta l > 0$ , and the cable stiffness vanishes and no element force exist when shortening occurs, i.e.  $\Delta l < 0$ .

This cable-stayed bridge has nine cables in each tower side. The dead load of the stiffening girder is considered to be equivalent to the vertical component of the pretension force of the cables and acted vertically at their joints. The inertia forces

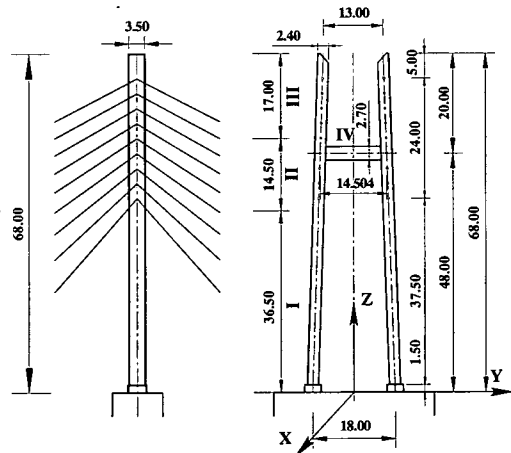

(a) Tower geometry (m)

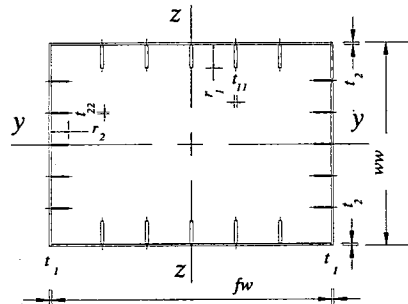

(b) Cross section

Fig. 1 Steel tower of cable-stayed bridge

**Table 1** Cross section dimensions of different tower parts (cm)

Tower parts	Outer dimension				Stiffener dimension			
	$f_w$	$w_w$	$t_1$	$t_2$	$r_1$	$r_2$	$t_{11}$	$t_{22}$
I	240	350	2.2	3.2	25	22	3.6	3.0
II	240	350	2.2	3.2	22	20	3.2	2.8
III	240	350	2.2	2.8	20	20	2.8	2.2
IV	270	350	2.2	2.6	31	22	3.5	2.4

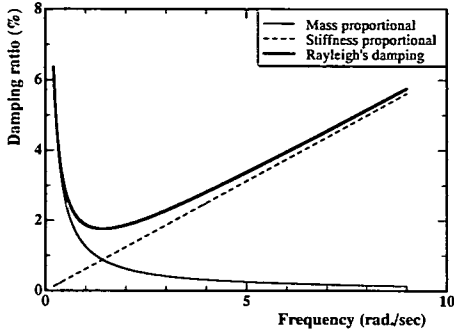

**Fig. 2** Damping ratio and frequency relationship

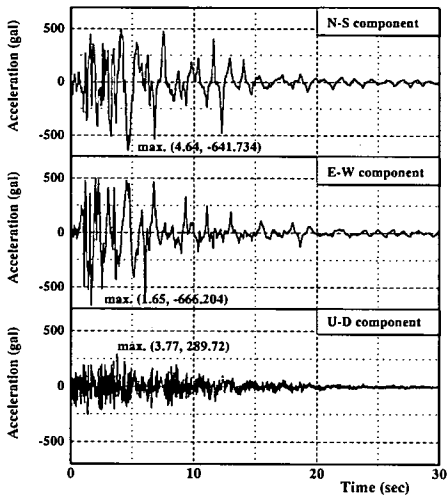

**Fig. 3** Strong ground motion recorded at JR Takatori observatory

acting on the steel tower from the stiffening girder is neglected. For the numerical analysis, the geometry and the structural properties of the steel tower is shown in **Fig. 1**, the tower structure has rectangular hollow steel section with internal stiffeners, which has different dimensions along the tower height and its horizontal beam as shown in **Table 1**.

**(2) Damping mechanism**

The damping mechanism in cable-stayed bridges is not well understood. A correct representation of structural damping cannot be formulated from a practical standpoint. Accordingly, simplified assumptions have to be used. In this analysis, the modal damping is treated in two

categories. First, considering physical elastic-plastic hysteresis loss in energy dissipation systems uses a phenomenological damping approach. In the second category, the damping matrix must be explicitly evaluated, where an equivalent viscous damping is introduced in the system in the form of damping matrix **[C]**, as shown in **Fig. 2**.

In this study, two spectral damping schemes are used: The first scheme based on the matrix of simplified damping assumption is used only to clarify vertical ground motion and damping scheme effects on the steel tower dynamic response, where the attenuation of tower structure is adopted the viscous damping of mass proportional type with damping coefficient to the first fundamental natural vibration mode as standard 2%. In the second scheme, Rayleigh's damping is used to form damping matrix as a linear combination of mass and stiffness matrices, which effectively captures the tower structures damping and is also computationally efficient. The damping ratio corresponding to the frequencies of the fundamental in-plane and out-plane modes of tower free vibration is set to 2%, this Rayleigh's damping scheme is adopted for all present parametric study.

**(3) Selected input ground motions**

In the dynamic response analysis, the seismic motion by an inland direct strike type earthquake that was recorded during Hyogoken-Nanbu earthquake 1995 of high intensity but short duration is used as an input ground motion to assure the seismic safety of bridges. The horizontal and the vertical accelerations recorded at the station of JR Takatori observatory<sup>3), 4)</sup>, as presented in **Fig. 3**, are suggested for dynamic response analysis of the steel tower of cable-stayed bridge at type II of soil condition due to its capability of securing the required seismic performance during the bridge service life. The selected ground motion has maximum acceleration of its components (N-S, E-W and U-D) equal to 642, 666 and 290 gal, respectively. From Fourier spectrum analysis, the predominant frequencies for N-S and E-W components are 0.83 and 0.81 Hz, respectively, which are relatively low, and that for the U-D component is 7.96Hz, which includes a high frequency components and indicates the vertical motion time lag to horizontal motions.

**(4) Vertical ground motion component**

Generally the vertical ground motion attenuates more rapidly than the horizontal motion, and the vertical motion effects are more evident in the near earthquake field. In fact it was observed that the vertical to horizontal peak ground acceleration ratio tends to assume greater values in the near field and

to decrease as the epicenter distance increases<sup>22)</sup>. Moreover, another aspect is not taken in consideration is the frequency content of the vertical motion, which is noticed to be significantly higher than that of the horizontal motion. Therefore the vertical component may be more dangerous as it is retained, since it may be close to the vertical frequencies of free vibration of many structures. There are a lot of records of instrumented structures, especially from the 1994 Northridge and 1995 Kobe earthquakes, which show a great amplification of the vertical ground motion.

**(5) Natural vibration analysis**

According to a number of full scale tests conducted for cables-stayed bridges, it is well known that the natural frequencies and natural mode shapes can be predicted with acceptable accuracy by means of linear elastic analyses that assume appropriate mass and stiffness distributions<sup>23)</sup>. Depending on the fundamental frequencies of the steel towers of cable-stayed bridge in relation to the dominant frequency content of the seismic input motion, shifting the natural period *T* of the tower would significantly reduce acceleration responses and tower member forces. The natural vibration analysis is carried out for the previous described steel tower modal. The natural periods, the effective modal mass and the damping coefficient for different vibration modes obtained from the analysis are listed in **Table 2**. The lowest vibration mode, with a 2.072 sec period, involves transverse vibration of the entire tower structure (right angle to the bridge axis). The second mode (0.9335 sec) is the longitudinal vibration (bridge axial direction). The vertical vibration modes have period of 0.5235 sec to 0.1559 sec including modes 4 and 8. It is apparent that the contributions for the first and second modes are not only of larger values. But, there is another mode of vibration with large value of contribution factor showing a very complicated dynamic behavior.

**Table 2** Summary of principal vibration modes for tower model

Mode order	Period sec.	Effective mass as a fraction of total mass	Viscous damping percent	Mode type
1	2.0723	33.195	2.00	H <sub>1</sub>
2	0.9335	30.330	2.00	L <sub>1</sub>
3	0.7726	0.000	2.18	T <sub>1</sub>
4	0.5235	0.034	2.81	V <sub>1</sub>
5	0.3751	1.735	3.68	L <sub>2</sub>
6	0.3625	0.080	3.79	H <sub>2</sub>
7	0.3296	0.000	4.12	T <sub>2</sub>
8	0.1559	34.079	8.35	V <sub>2</sub>
Sum	--	99.423	--	--

H: transverse vibration (in-plane), T: torsional vibration  
L: longitudinal vibration (out-plane), V: vertical vibration

**4. EFFECTS OF VERTICAL GROUND MOTION AND DAMPING**

The principal effect of the vertical motion is the generation of fluctuating axial forces uncoupled from the lateral forces in tower legs. These axial forces are added to the axial forces correlated with the in-plane moments and as a result the compression and tension axial forces in tower legs could reach greater level than that with the horizontal motions alone. The effects of the vertical motion on tower seismic response are studied with the tower model described before. Two cases of analysis for the input ground motion for each spectral damping scheme (mass proportional or Rayleigh's damping) are considered as follows: The first; under the horizontal components only, and the second; under both the horizontal and the vertical components. The vertical excitation main effects can be stated and briefly explained in the following.

**(1) Effects on tower axial response**

In order to observe directly some of the effects of the vertical motion, the axial force time histories at the tower base are given in **Fig. 4**. For the mass proportional damping, it is evident the superposition of the axial force variations induced by the vertical motion with that due to the horizontal motions and a higher frequency feature. The axial force extreme values could reach great values with the vertical motion, since the maximum compression axial force at the tower base with and without consideration of vertical ground motion becomes, in fact, 4.01 and 3.13 times the initial axial force due to gravity loads, while the maximum tension axial force becomes about 2.46 and 1.36 times the initial axial force, respectively. The contribution of the vertical motion to the total axial force can be comparable to that of the horizontal motions, since that contribution to the extreme compression and tension values of axial forces in the tower base increases and it reaches about 28% and 81% of the total axial force for that case without consideration of vertical ground motion, respectively.

For the Rayleigh's damping scheme, it can be concluded that the vertical motion has slightly effects in axial forces generation, which are uncoupled to that due to lateral forces and have a higher frequency. The axial forces at tower base due to the overturning moments are significant and the vertical motion has small contribution to the total axial force compared to that of the horizontal motion, since the extreme compression and tension values of axial forces in the tower base indicate that the contribution of the vertical motion reaches about 10% and 6% of the total axial force for that case without vertical ground motion, respectively. For the

case of horizontal input ground motions only, the tower dynamic response is slightly affected by the damping scheme. Moreover, it can be concluded that the damping scheme in the dynamic analysis essentially affects structure seismic response.

**(2) Effects on tower flexural response**

The moment-curvature diagram of the tower base, obtained with and without vertical motion, as shown in Fig. 5, presents the characteristics of the column behavior under coupled axial and lateral force variations. For the mass proportional damping, it can be observed that the asymmetry strength and moment curvature diagram shift due to fluctuating axial force effect. The diagram obtained with the vertical motion reveals an unusual and irregular shape with significant fluctuations in strength and stiffness due to the axial force-moment interaction. The contribution of vertical motion in maximum curvatures reaches about 31% of that case without vertical motion, and this indicates the lower dissipation capacity considered with the vertical excitation. However this is not only reason of the lower dissipated energy, since the tower hysteresis energy decreases as the curvature experiences greater values, moreover another cause is the irregular shape of the hysteresis loops. It can be seen

also the growth of the inelastic behavior with the vertical ground motion, since the axial force fluctuation has the ability of generation of new plastic zones through the tower elements.

For the Rayleigh's damping scheme, the tower response with vertical ground motion shows very slightly effects in the tower flexural behavior. Moreover, The damage caused by the horizontal motions is similar to that caused by the vertical and horizontal motions. Since tower overall flexural response is not significantly altered by the fluctuation in the axial force associated to the vertical excitation. It can be observed that the analysis using Rayleigh's damping scheme displays more growth of tower inelastic behavior that can be attributed to greater input energy of ground motion leading to cause more damage and ductility demand.

**(3) Effects on tower acceleration response**

The vertical motion detrimental influence on tower acceleration response can be clarified through acceleration time history study. For the first damping scheme, as shown in Fig. 6(a), the tower top horizontal acceleration is resulted to increase of a non-negligible amount with the vertical motion. The extreme in-plane acceleration values are seen that the contribution of the vertical motion increases and it reaches about 81% of that for case without consideration of vertical ground motion, the in-plane acceleration for the cases with and without considering the vertical motion could reach 5.94 and 3.28 times that of the input ground motion, respectively. For the second damping scheme, it can be concluded that the vertical motion has no significant effect on the acceleration tower response, but it is characterized by effectiveness response and greater energy that causes more damage for tower

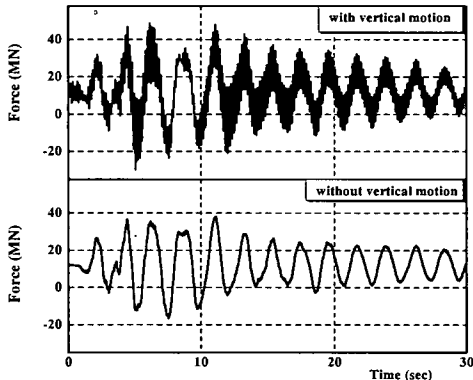

(a) Mass proportional damping scheme

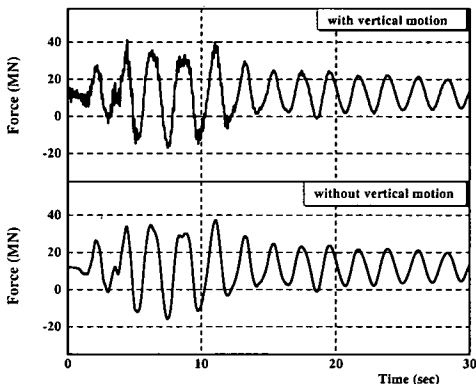

(b) Rayleigh's damping scheme

Fig. 4 Vertical force time history at tower base

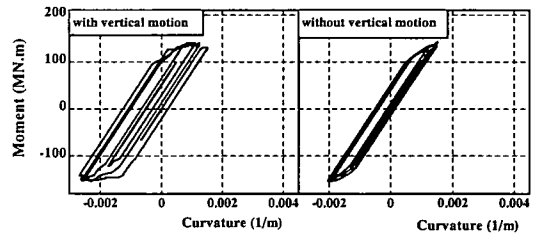

(a) Mass proportional damping scheme

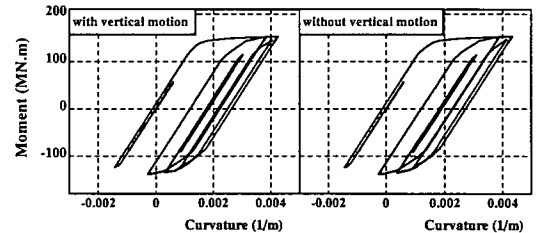

(b) Rayleigh's damping scheme

Fig. 5 Moment-curvature diagrams at tower base

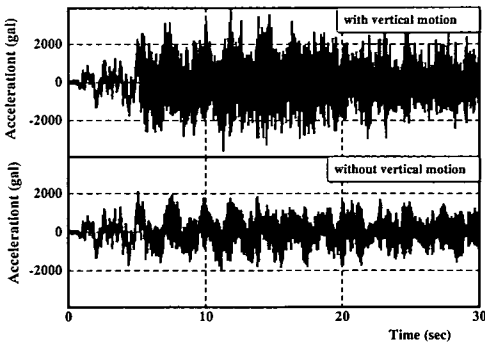

(a) Mass proportional damping scheme

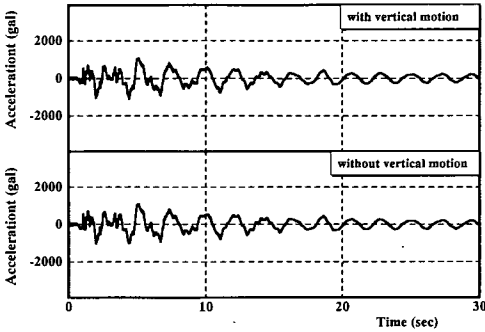

(b) Rayleigh's damping scheme

Fig. 6 In-plane acceleration time history of the tower top

structure, as shown in Fig. 6(b). The vertical ground motion effect on seismic response depends totally on the spectral damping scheme considered for nonlinear dynamic analysis. For the mass proportional damping scheme, the vertical motion displays significantly effect on tower seismic response, which may be attributed to the amplification of high frequencies mode of tower vibration included in the frequency content of the vertical motion, in terms lead to overestimation of the tower response. For the Rayleigh's damping scheme, it is appeared that the vertical motion has slightly effect on tower dynamic behavior due to high damping ratio for high frequency modes, which is pronouncedly affected by the vertical ground motion that has high frequency content compared with that of horizontal ground motions. The Rayleigh's damping could be recommended for conservative nonlinear seismic response of high-rise tower structures.

## 5. EFFECTS OF CONSTRUCTION INITIAL IMPERFECTIONS

### (1) Initial geometric imperfections

Initial imperfections in structures that have not been subjected to damage usually result from the fabrication process and the strength of a thin-walled

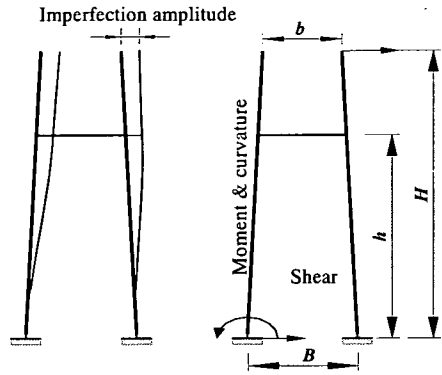

Fig. 7 Initial geometric imperfection pattern and different measured aspects of tower response

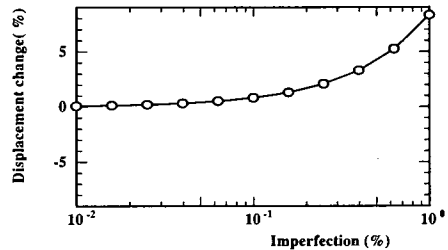

Fig. 8 Displacement & imperfection amplitude relationship

steel member is particularly sensitive to imperfections in the shape of its natural vibration modes. The amplitude of imperfections in the lowest eigenmodes of vibration is often sufficient to characterize the influential imperfections<sup>19</sup>. The initial geometric imperfection is applied by modifying the nodal coordinates using a field created by scaling the appropriate vibration eigenvector obtained from an elastic natural vibration analysis of tower model.

The dynamic response of the steel tower with consideration of initial geometric imperfection is investigated for different imperfection amplitudes of range from 0.01 up to 1% of tower height. The initial geometric imperfection is taken to be the first fundamental vibration mode pattern. Fig. 7 describes the mode shape of the steel tower obtained from eigenvalue analysis. The mode is normalized so that the modal displacement at tower top is adjusted to the imperfection amplitude. The effects of the magnitude of initial geometric on the extreme values of in-plane displacement of tower top, shear force, in-plane moment and curvature at tower base are presented.

It can be concluded that the initial geometric imperfection within its design range of upper limit equal to 0.1% slightly affect on the tower seismic response but beyond this range, these effects are characterized by rapidly and nonlinearly increase and become significant as the initial imperfection approach severe values (1%). The extreme values of

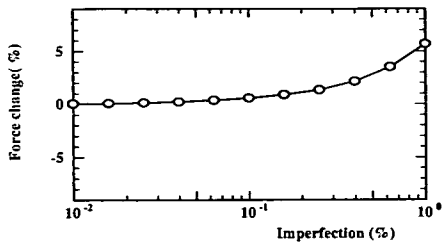

Fig. 9 Shear force & imperfection amplitude relationship

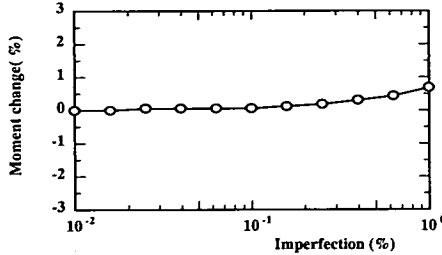

Fig. 10 Moment & imperfection amplitude relationship

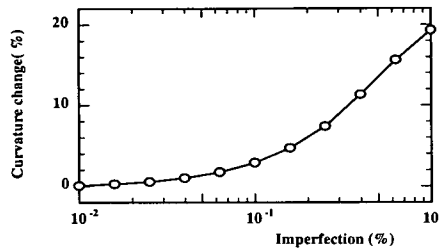

Fig. 11 Curvature & imperfection amplitude relationship

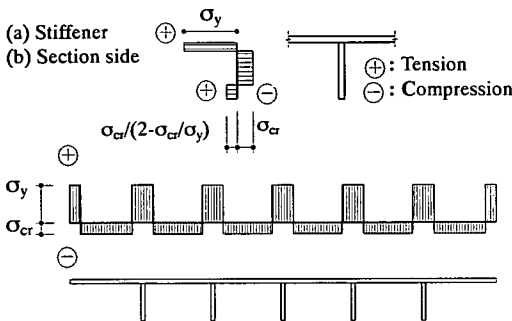
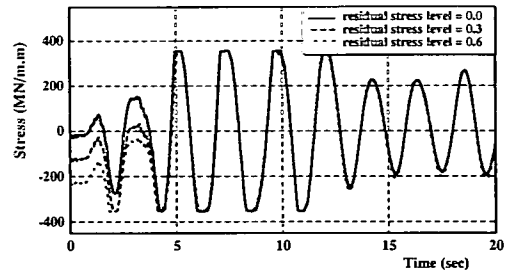
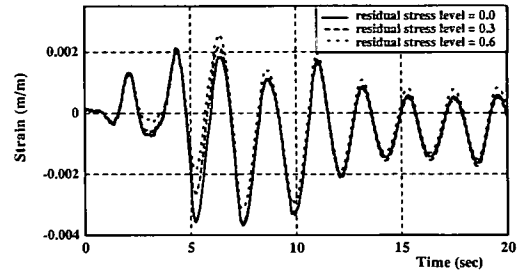

Fig. 12 Residual stresses in each side tower cross section

in-displacement at tower top and shear at tower base increase as imperfection amplitude increase under the same loading and have values 8% and 6% of that of perfect tower at maximum imperfection 1% of tower height as given in Figs. 8 and 9, respectively. But the extreme values of bending moment at tower base slightly increase up to 1.5% of that of perfect tower as a result of tower inelastic response that is characterized by large deformation corresponding to small force response, as illustrated in Fig. 10. Moreover, the imperfection amplitude has pronounced effects on curvature at tower base and



(a) Stress of compression residual stress fiber at tower base



(b) Strain of compression residual stress fiber at tower base  
Fig. 13 Stress and strain time histories

as a consequence the tower structure response, since the curvature increases up to 20% of that of perfect tower as shown in Fig. 11.

## (2) Residual stresses

The presence of longitudinal residual stresses in stiffened rectangular hollow cross section is mainly attributed to the welding of stiffening members in addition to hot rolling of the hollow cross section. The residual stresses in the weld, stiffener and hollow section material in the vicinity of the weld are close to the yield as a result of the contraction of the welds. The magnitude and distribution of the residual stress are governed by welding parameters such as heat input and cooling rate of the welding process adopted for fabrication processes. To model the distribution of longitudinal membrane residual stresses in the cross section and the plasticity spread, the integration through the division of fiber model is considered to be sufficient. Fig. 12 illustrates a typical residual stress pattern<sup>24)</sup> of tower cross section that is used in the computational model. It has been presented that the magnitude of the compressive residual stresses increases as the component plates of hollow section slenderness becomes smaller, values of stress up to 75% of the yield strength have been measured<sup>25)</sup>.

The formation of residual stresses is inevitable in any welding and hot rolled operations, when they are superimposed on the externally applied stress fields, the residual stresses can result in significant differences in the performance of welded structures. The effects of residual stresses on the dynamic



response of the steel tower is studied by varying residual stress level, where the compressive residual stresses range from 0.0 up to 0.60 times with interval of 0.1 of the yield stress are used to represent the condition of stress relieved, from lightly welded to heavily welded stiffener to the cross section. It can be observed that residual stresses have a more pronounced effect on the tower dynamic response, which will yield at a lower load stress due to the presence of compressive residual stresses. It can be seen how the applied membrane stresses is used to reflect the removal of residual stresses through the first cycle of the stress response in Fig. 13 (a). But the residual effects extent over most of time history of strain response, and could be presented as peak time lag and decreasing plastic deformation capability as illustrated in Fig. 13(b). The tower top displacement decreases as the residual stress level increases, due to plastic deformation decrease as shown in Fig. 14.

In addition, the tower strength and stiffness are reduced by the presence of residual stresses and decrease with residual stress level increase as seen in Figs. 15 and 16. The tower flexural response is

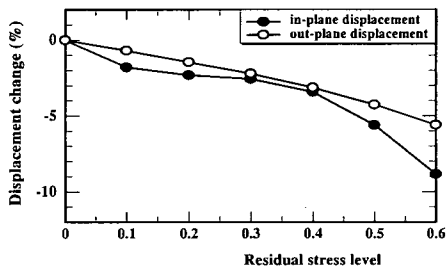

Fig.14 Displacement & residual stress level at tower top

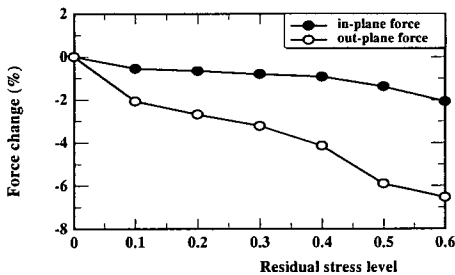

Fig. 15 Shear force & residual stress level at tower base

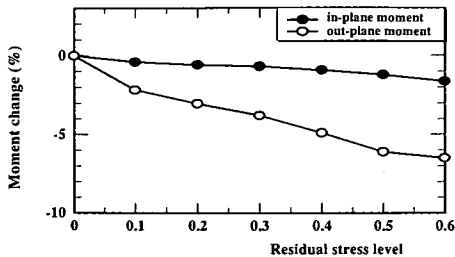
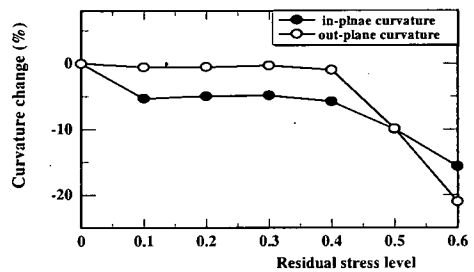

Fig. 16 Moment & residual stress level at tower base

slightly affected by the presence of residual stress up residual stress level about 0.4, behind this level, the tower base curvature abruptly increases up to 20% of that of the original tower, as illustrated in Fig. 17(a), this behavior could be attributed to the peak time lag in curvature time history response as indicated in Fig. 17(b). From the total, damping and strain energies of the whole tower study, it is appeared the energies decrease in gradually as the compression residual stress increases and much effect on strain energy. This reduction can be attributed to decreasing of tower plastic deformation capability and gradual decreasing of tower stiffness due to presence of compression residual stresses, as given in Fig. 18.

In general, it can be concluded that the residual stress effects on the tower seismic response are sensitive to its stiffness in the longitudinal and transverse directions. Since the tower deformations response in the out-plane direction are more sensitive to the existence of residual stresses, which can be attributed to the long period of vibration and more flexibility of tower in-plane direction compared



(a) Curvature & residual stress level at tower base

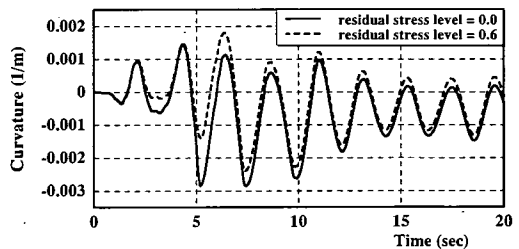

(b) Time history

Fig. 17 Curvature at tower base

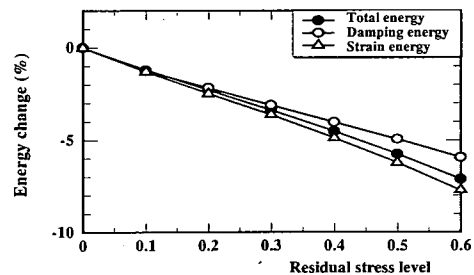

Fig. 18 Total, damping and strain energies of the whole tower & residual stress level relationship

to that of the out-plane direction. The residual stresses within the design range of upper limit equal to 0.3 affect the tower seismic response not more than 3% and 5% for displacement and in-plane curvature demand, respectively. Also, these effects are not more 4% for both out plane shear and flexural capacity. The other aspects of tower seismic response are slightly affected by residual stresses values up to the design range upper limit. The residual stresses have the time lag effect on tower peak response, which can be noted from curvature rate of change at residual stress level of 0.4.

## 6. LOW YIELD MATERIAL ENERGY DISSIPATION SYSTEM

The design of a passive energy dissipation system depends on many factors, including the period of original tower configuration, the input ground motion response spectrum, force deformation relationship, and so on. The design of isolation system should be able to provide supplemental damping to significantly reduce tower response to ground motion and dissipation a large portion of earthquake input energy through inelastic deformations in certain positions, which could be easily retrofit after damage. Thus the spectral acceleration and structural element forces could be significantly reduced when they are compared to that of original tower. The nonlinear dynamic behavior and seismic performance of the steel tower under three dimensional great earthquake motion are studied for three different cases, a case of original tower and other two cases of proposed energy dissipation system. In these two cases, the concentration of inelastic behavior along the tower horizontal beam by reduction of its strength is considered, this reduction is done by using low yield steel material instead of cross section dimensions reduction. Two yield stresses are used that equal to 235 MPa and 100 MPa corresponding to medium and low yield level equal to 0.67 and 0.28 relative to that of original tower, respectively.

The performance of the proposed energy dissipation system is analyzed by comparing the energies time history, where the input energy is defined as the total energy related to inertia forces induced by the ground motion. It is appeared that the proposed energy dissipation system has two effects on the tower response: The first is to increase the tower structural system ability to reflect a portion of earthquake input energy, since as the horizontal beam yield early attains, the tower becomes more flexible. In effect, the increased flexibility acts as a filter. Secondly, it increases the amount of damping and dissipation energies through

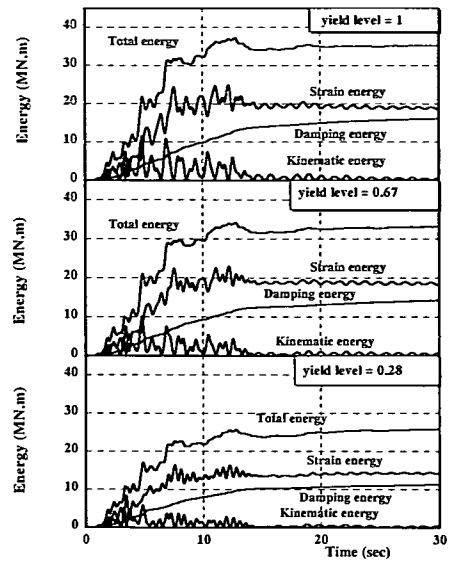
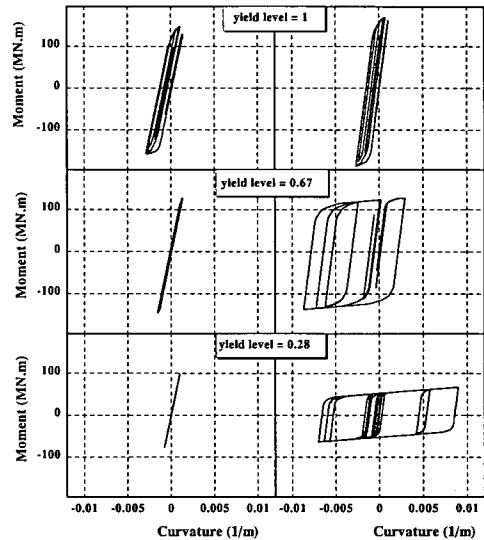

Fig. 19 Different energies time history of the whole tower



(a) At tower base (b) At horizontal beam end  
Fig. 20 Moment & curvature relationship

inelastic deformation hysteresis. The calculated results of different yield levels show effective energy dissipation through the horizontal beam. As the yield level decreases, the energy dissipation system becomes more effective in energy absorption and damage control, as seen in Fig. 19.

As the yield level of horizontal beam material decreases, thus the load capacity of tower horizontal beam decreases and forces redistribution in tower structural elements occurs. It can be seen from Fig. 20(b) that more concentration of inelastic behavior and ductility at tower horizontal beam is attained as yield level change for low values, which

is easy to inspect and repair if necessary. The rest of the structure approaches elastic behavior as yield level decreases, thus there is a possibility of eliminating permanent damage and minimizing the extent of retrofit. The main tower parts attain almost elastic behavior at study case of yield level equal to 0.28, as seen in Fig. 20(a).

In general, the isolated tower exhibits elastic response due to the redistribution of the seismic forces to the tower elements in accordance to their strength. It can be concluded that the proposed energy dissipation system is effective in controlling the maximum tower displacement, since the displacement tower response decreases as the horizontal beam capacity decrease, as illustrated in Fig. 21. The better performance of the isolation proposed energy dissipation system is indicated by comparing the reaction force time history at the tower base for different levels of yield strength of the horizontal beam. It is illustrated from Figs. 22 and 23 that the isolated tower provides pronounced reduction in the reaction forces response compared to the original tower response, this reduction becomes more pronounced as the yield level decreases, due to seismic forces redistribution to tower elements according to their strength and stiffness. The proposed energy dissipation system effect can be understood from the in-plane shear and vertical force time histories at tower base. The tower main structures approach elastic behavior as yield capacity of horizontal beam decreases. Since for yield level equal to 0.67, tower flexural response represented in the moment ratio relative to yield moment capacity ( $M_y$ , that equal to 130 MN·m) time history at tower base, enters the plastic response four times compared with the original tower enters

the plastic response seventh times, while for low yield level equal to 0.28, the elastic behavior is displayed along the time history, as seen in Fig. 24.

The hysteretic dampers of low yield steel material can provide relatively large energy dissipation through their materials that are strained beyond their yield limits, thus can be cost effective. The hysteretic dampers cannot be activated as dampers unless their materials receive inelastic excursions, so the hysteretic dampers are effective only for larger earthquake excitation that can be understood from this study, but fail in providing the required damping for smaller vibrations. Another aspects of post-yield buckling capacity should be considered in the design. In this case of study, as horizontal beam receive inelastic excursions; the buckling effective length could get larger, as a result, the load carrying capacity decreases.

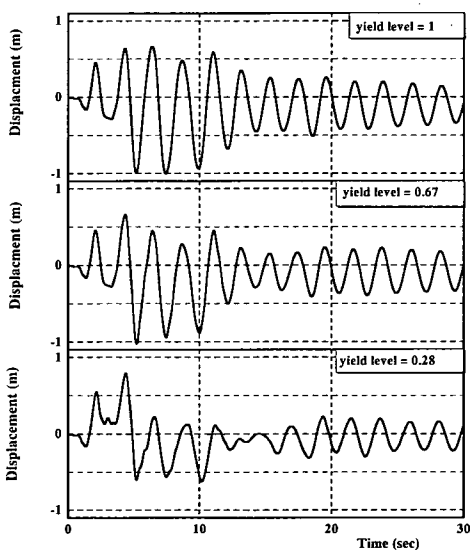

Fig. 21 In-plane displacement time history at tower top

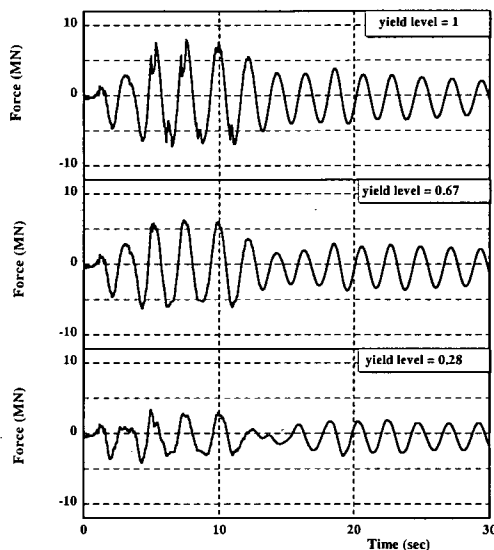

Fig. 22 In-plane shear force time history at tower base

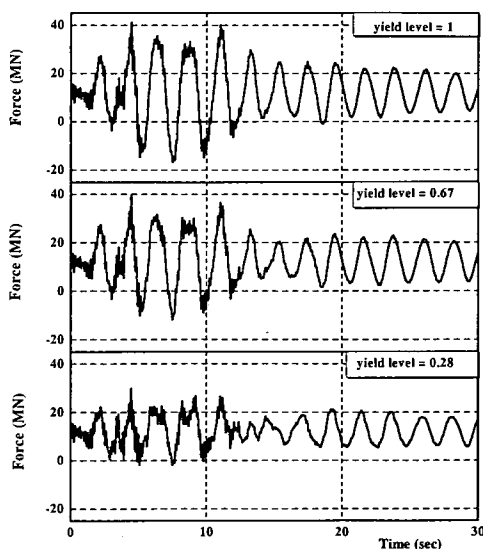

Fig. 23 Vertical force time history at tower base

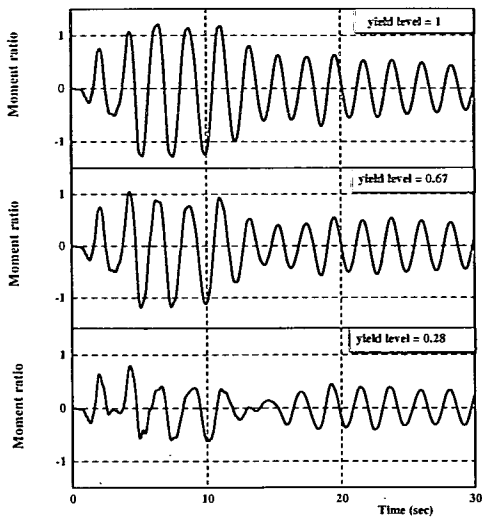

Fig. 24 Moment ratio time history at tower base

The buckling load carrying capacity is calculated for the worst case of no contribution of horizontal beam to the tower legs stiffening, it is found to be equal to 49.5 MN, which is much greater than the corresponding tower response. Moreover, the proposed low yield hysteretic dampers lead to effective reduction of vertical force response as yield level decreases, as a result buckling demand decreases, as shown in Fig. 23.

## 7. EFFECTS OF TOWER MODAL SHAPES

The natural vibration periods of the in-plane, out-plane and torsion fundamental modes of the steel tower with different modal shapes have been studied for different height and length of the horizontal beam. A detailed natural vibration characteristic is provided for horizontal beam different height relative to the total tower height (height ratio,  $h/H = 39/68 - 68/68$ ) and different width at tower top relative to that at tower base (length ratio,  $b/B = 13/18 - 3/18$ ). Fig. 25 presents the natural period of these three modes of vibration and height and length ratios relationship.

The effectiveness of the tower modal shapes can be measured by their capabilities in the energy dissipation through shifting natural period of the fundamental mode and increasing structural damping. The natural vibration analysis indicates that the height and length of tower horizontal beam have effective role in shifting the primary period of the tower free vibration, and slightly affect the higher mode of vibration. Longer natural period can be attained by either horizontal beam height ( $h/H$ ) relative to tower height or tower top to base width ratio ( $b/B$ ) increase. For the original steel tower of cable-stayed

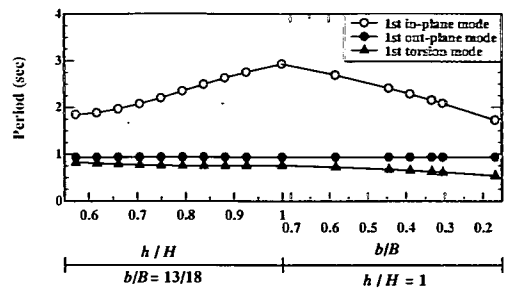

Fig. 25 Natural period & horizontal beam height/length relation

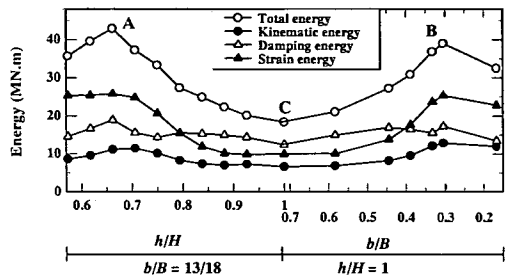

Fig. 26 Total, damping and strain energies of the whole tower & horizontal beam height/length relationship

bridge, the better performance could be attained by moving the horizontal beam from its current designed at  $h/H = 48/68$  toward tower top. This modification in tower design could lead to natural period about 1.5 times longer, hence reduces the seismic demand required for earthquake mitigation.

It is indicated from Fig. 26 through the energies extreme values study that the horizontal beam has two critical positions corresponding to point A ( $h/H=45/68$ ,  $b/B=13/18$ ) and point B ( $h/H=68/68$ ,  $b/B=5.5/18$ ), where the maximum total energy occurs, as a result the seismic demands are increased. The kinematic and damping energies is slightly affected by the horizontal beam position of tower, while the total and strain energies along the range between critical points A and B decrease highly nonlinear as either the height ratio or the length ratio increase up to optimum position of horizontal beam corresponding to point C. The tower base shear and vertical force variations with different horizontal beam height and length ratios are described in Figs. 27 and 28, respectively, which confirm the optimum position of horizontal beam at tower top as detected from the energetic study. The height of horizontal beam has effective role in the dynamic response of steel tower depends to large extent to tower shapes<sup>15</sup>, including the horizontal beam position and strength represented in material yield level. The effects of height and length of the horizontal beam on tower dynamic response are discussed through time history analysis to examine the tower shapes effects. For this purpose, three different cases of tower modal shape, as illustrated in Fig. 29, are considered as follow:

- Case I: The original tower of cable-stayed bridge.
- Case II: Portal frame-type where the horizontal beam in case I is raised to tower top.
- Case III: Inverted V-type where the tower top length decreases from case II up to 3 m.

The natural period of the predominant modes of free vibration for studied cases of tower model shapes is given in Table 3, where the symbols  $H_1$ ,  $L_1$  and  $T_1$  are the first natural mode in the direction of the right angle to bridge axis (in-plane), of bridge axis (out-plane) and torsion, respectively. The first natural periods of out-plane and torsion modes are smaller than that of in-plane mode due to the stiffening of cables. It is seen that the natural period

of the portal frame-type tower has tendency to be getting longer in compared with the inverted V-type and original tower (H-type) because of more flexibility of tower frame structure due to its height increases and also there is a massive horizontal beam situated on the tower top.

Fig. 30 displays the energy time history for different cases of tower modal shape. The portal frame-type tower has enough flexibility to reflect most of the absolute input energy by flexibility filtering; the damping energy becomes larger and reaches about 80% relative to input energy. Moreover, the strain energy dissipated through tower inelastic hysteretic deformation decreases, since the tower still keeps elastic behavior as illustrated in Fig. 31. The hysteresis of the other types of tower modal shape (cases I and III) becomes larger and pronouncedly displays inelastic behavior especially for H-type. The largest inelastic deformation damage has been attained, leading to high strain energy dissipated through tower hysteric behavior. Moreover, the total input energy is getting higher, which requires greater seismic demand for mitigation of earthquake hazards. Fig. 32 indicates the trajectory of tower top displacement response in the two horizontal directions. The right tower top

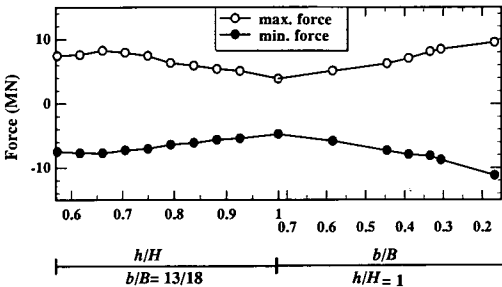

Fig. 27 In-plane shear at tower base & horizontal beam height/length relationship

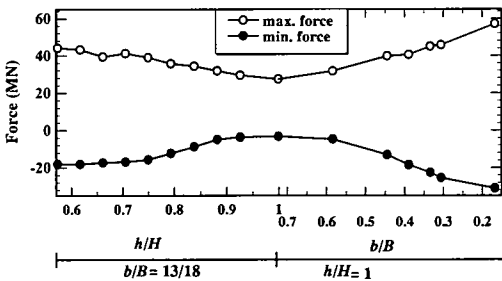

Fig. 28 Vertical force at tower base & horizontal beam height/length relationship

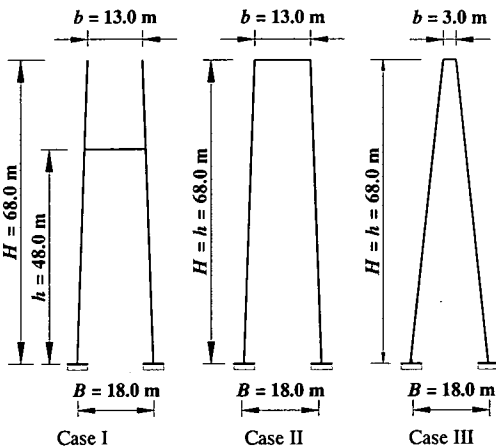

Fig. 29 Tower modal shapes

Table 3 Natural period for tower different modal shapes (sec)

Mode type	Cases of tower modal shapes		
	Case I	Case II	Case III
$H_1$	2.072	2.928	1.727
$L_1$	0.934	0.935	0.935
$T_1$	0.773	0.761	0.543

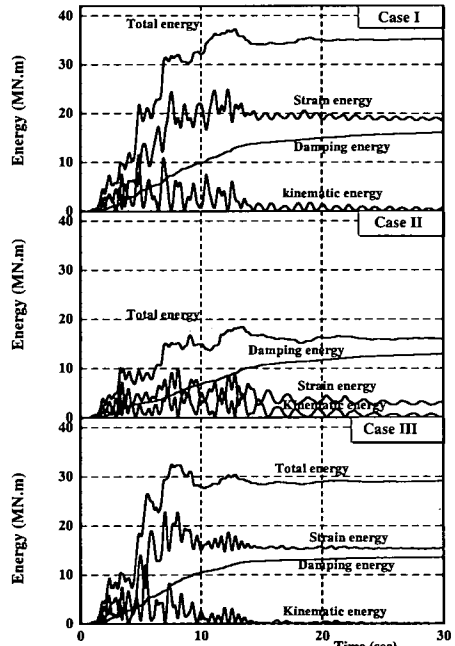

Fig. 30 Different energies time history of the whole tower

displacement response is considered. The vertical axis is the in-plane displacement (right angle to bridge axis direction) and the horizontal axis is the out-plane displacement (bridge axis direction). The results indicate that all studied three cases are characterized by in-plane larger displacement than that of the out-plane response, which is related to long period of the in plane free vibration compared with the out-plane vibration. In addition, the existence of cables reduces tower shape effects on the out plane tower displacement response. The H-type (case I) tower has the largest in-plane displacement response among three considered tower shapes due to the absence of frame action at tower top. The tower part above the horizontal beam approaches to a cantilever behavior, also it is noted the asymmetric in-plane displacement that related to torsional vibration effects. The portal frame-type (case II) tower displays reasonably large displacement, since it has the longest period of vibration and massive effect of the horizontal beam

at tower top. The inverted V-type (case III) tower model displays the smallest top displacement response in both directions due to stiff frame action of this shape and short period of in-plane and torsional vibrations. The dynamic response of each tower model is examined on axial force at tower basement as illustrated in Fig. 33, which shows the orbits of axial force response that occurs at both sides of the tower basement.

The vertical and horizontal axes are the axial force response at right and left sides of tower basement, respectively. A dead load equivalent to the stiffening girder weight is equal to 12.15 MN and it acts on both sides of the tower basement through cables. It is noted that tower modals have symmetrical form of axial force dynamic response around the dead load. The inverted V-type has the largest axial force response, where the maximum compressive and tension axial forces are about 4.70 and 2.55 times of the gravity loads, the large negative reaction makes the problem that the anchor

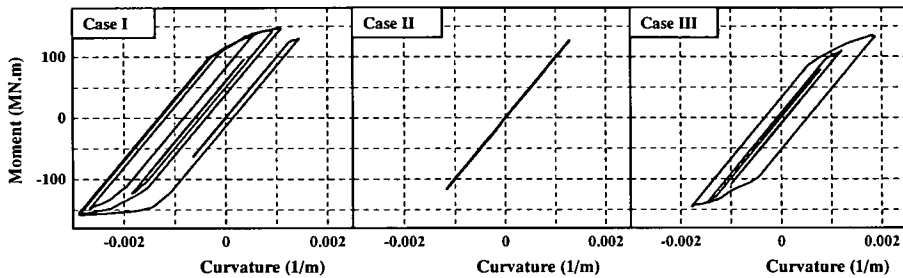

Fig. 31 Moment curvature relations at tower base

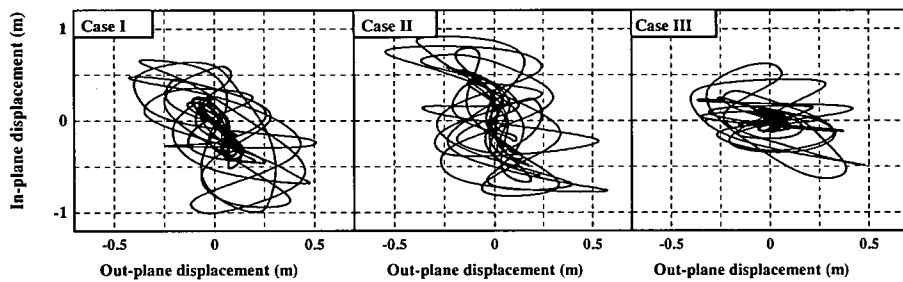

Fig. 32 Trajectory of response sway displacement of tower top

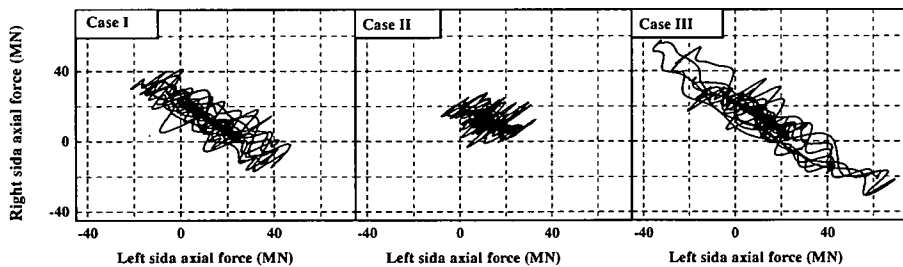

Fig. 33 Axial force relation at tower bases

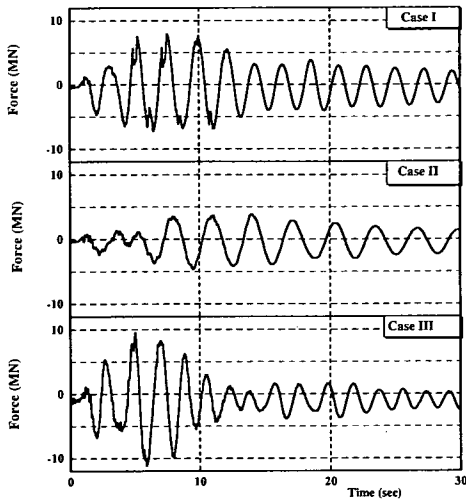

Fig. 34 In-plane force time history at tower base

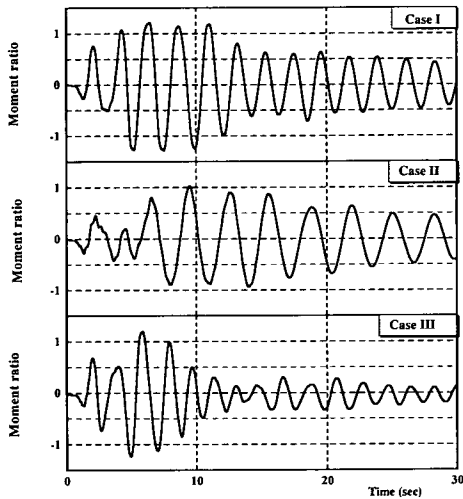

Fig. 35 In-plane moment time history at tower base

bolts may fail in the lift up and the safety of the tower should be considered. The same behavior but slightly less severe can be seen for the H-type (original tower), where the maximum compressive and tension axial forces are about 3.39 and 1.39 times of the gravity loads. On the other side, the portal frame-type (case II) model displays reasonable axial force response with small amplitude, since the maximum compressive and tension axial forces are about 2.26 and 0.27 times of gravity loads. The current results prove again the effectiveness of the horizontal beam position on tower axial force dynamic response. The change of horizontal beam height from that of the original tower ( $h/H=48/68$  m) toward tower top ( $h/H=68/68$ ) will reduce the compressive and tensile axial forces at tower base about 34% and 81% of that of original tower, respectively, and almost the uplift problem disappears that secure the tower seismic response

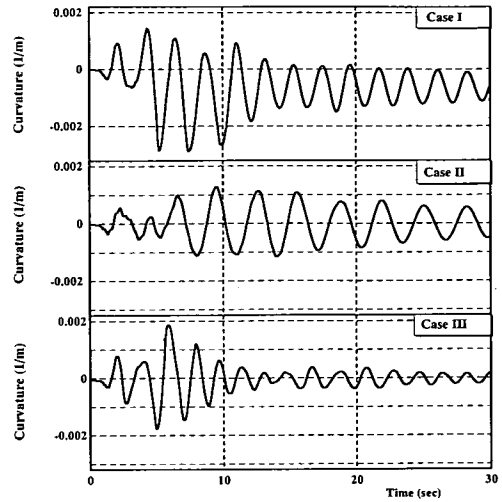

Fig. 36 In-plane curvature time history at tower base

against anchor bolts lift up failure. The severe axial force response of the inverted V-type could be attributed to inclination of the tower legs that leads to significant flexural-axial interaction and increases the flexural contribution in the tower vertical force response under external seismic excitation.

The reaction force time history at the tower base for different tower shapes could indicate the better performance of the tower modal shapes, as indicated in Fig. 34. It is found that the portal frame-type tower (case II) provides pronounced reduction in the reaction force response compared to the original tower response (case I), and its response is characterized by long period of vibration and elastic behavior, while the inverted V-type displays larger shear as well as axial response. From the moment ratio relative to the yield moment capacity ( $M_y$ ) at the tower base, which is equal to 130 MN·m, the original tower enters the inelastic response many times within the first twelve seconds, which explains the large damage occur.

The inverted V-type tower enters the inelastic response three times within the first ten seconds leading to less damage compared to case I, while the portal frame-type tower still has elastic response along the time history, as shown in Fig. 35. The curvature time history at tower base displays residual deformation and damage for original tower, however, the residual deformations disappear for both portal frame and inverted V-type models due to elastic behavior of portal frame-type and ability of inverted V-type to restore symmetric behavior with no residual deformation even it has inelastic deformation at early stage of response, as illustrated in Fig. 36.

## 8. CONCLUSIONS

Analytical parametric study on steel tower of cable-stayed bridges is performed for investigation the individual influence of different design aspects on its dynamic characteristics, such as damping scheme, input ground motion, allowable initial imperfections, energy dissipation and tower modal shapes. A finite element procedure based on total Lagrangian formulation for the nonlinear dynamic analysis of steel tower of cable-stayed bridge under three dimensional great earthquake ground motion is carried out. From the performed investigations and discussions, the following conclusions can be summarized:

- (1) The effect of vertical ground motion has highly dependence on damping scheme. The Rayleigh's damping is more effective in high frequency range, which leads to slightly effects of the vertical ground motion on tower dynamic response. The Rayleigh's damping could be recommended for conservative nonlinear seismic response of high-rise towers.
- (2) For mass proportional damping scheme, a significant axial force fluctuations due to vertical motion inertia forces affects the tower behavior and as a consequence the global structural response. The contribution of the vertical motion to extreme compression and tension axial forces at tower base reaches about 28% and 81% of that of horizontal motions only, respectively. Moreover the tower axial forces response is characterized by high frequency. The consideration of horizontal excitations only could underestimate the curvature ductility demand.
- (3) For Rayleigh's damping scheme, the tower response with vertical motion shows slightly effects on its flexural behavior, but more growth of inelastic behavior arises due to greater input energy. The contribution of the vertical motion to extreme compression and tension axial forces at tower base reaches about 6% and 10% of that case of horizontal motions only, respectively.
- (4) The initial geometric imperfections of tower fundamental vibration mode pattern, within its design range of upper limit equal to 0.1%, slightly affect the tower seismic response. But beyond this range, these effects are characterized by rapidly and nonlinearly increase and become significant as the initial imperfections approach severe value (1%).
- (5) The normal stress distribution is affected by the residual stress; as a result, the tower load carrying capacities and stiffness decrease as the residual stress level increases. Moreover, the residual stress has detrimental effects on tower structural performance, which can be characterized by decreasing plastic deformation capability.

(6) The residual stress effects on the tower seismic response are sensitive to its stiffness in the longitudinal and transverse directions. These effects within the design range of upper limit equal to 0.3 on the tower seismic response are not more than 5% that of perfect tower response.

(7) The proposed energy dissipation system demonstrates its capability and effectiveness in reducing structural elements forces and controlling tower maximum displacement through its capability achieving the concentration of inelastic behavior at tower horizontal beam and keeping the rest of the structure elastic behavior as yield level decreases. The post-yield buckling capacity should be considered in the design of tower structures.

(8) This technique could add damping primarily by material hysteresis and increase tower flexibility as the horizontal beam yield early attains, in terms tower structural system ability to reflect a portion of earthquake input energy increases. The energy dissipation system becomes more effective in energy absorption through the horizontal beam.

(9) The portal frame-type tower has the longest natural period and enough flexibility to reflect most of the absolute earthquake input energy by flexibility filtering. The damping energy could reach larger values relative to input energy about 80% and minimum strain energy is dissipated through inelastic hysteric deformations of the tower.

(10) The inverted V-type has the largest axial force response, where the maximum compressive and tension axial forces are about 4.70 and 2.55 times of the gravity loads, respectively. The large negative reaction makes the problem that the anchor bolts may fail in the lift up and the safety of the tower should be considered.

(11) The effectiveness of the horizontal beam position on tower axial force dynamic response is assured. The change of horizontal beam height from that of the original tower ( $h/H=48/68$ ) toward tower top ( $h/H=68/68$ ) reduces the compressive and tensile axial forces at tower base about 34% and 81% of that of original tower and almost the uplift disappears.

## REFERENCES

- 1) Ali, H. M. and Abdel-Ghaffar, A. M.: Modeling the nonlinear seismic behavior of cable-stayed bridges with passive control bearings, *Computers & Structures*, Vol. 54, No. 3, pp. 461-492, 1995.
- 2) Hayashikawa, T. and Abdel Raheem, S. E.: Nonlinear dynamic behavior of steel tower of cable-stayed bridges with passive energy dissipation system, *Journal of Structural Engineering, JSCE*, Vol. 48A, pp. 863-874, 2002.
- 3) Committee of Earthquake Engineering: *The 1995 Hyogoken-Nanbu Earthquake, Investigation into Damage to Civil Engineering Structures, JSCE*, 1996.



- 4) Japan Road Association: *Specification for Highway Bridges-Part V Seismic Design*, Maruzen, Tokyo, 1996.
- 5) Bozorgnia, Y., Niazi, M. and Cambell, K. W.: Characteristics of free-field vertical ground motion during the Northridge earthquake, *Journal of Earthquake Spectra*, Vol.11, No. 4, pp. 515-525, 1995.
- 6) Papazoglou, A. J. and Elnashai, A. S.: Analytical and field evidence of the damaging effect of vertical earthquake ground motion, *Earthquake Engineering and Structural Dynamics*, Vol. 25, pp. 1109-1137, 1996.
- 7) Diotallevi, P. P. and Landi, L.: Effect of the axial force and of the vertical ground motion component on the seismic response of R/C frames, *Proceedings of 12th. World Conference on Earthquake Engineering*, Paper No. 1026, 2000.
- 8) Saadeghvaziri, M. A. and Foutch, D. A.: Behavior of RC columns under non-proportionally varying axial loads, *Journal of Structural Engineering, ASCE*, Vol. 116, No. 7, pp. 1835-1856, 1990.
- 9) Hayashikawa, T., Aly, G. A., Abdel Raheem, S. E.: Effect of vertical ground motion on seismic response of steel tower of cable-stayed bridges, *Proceedings of Hokkaido chapter of the Japan Society of Civil Engineers, JSCE*, No. 58(A), pp. 112-115, 2001.
- 10) Usami, T. and Fukumoto, Y.: Local and overall buckling of welded box columns, *Journal of Structural Division, ASCE*, Vol. 108, No. 3, pp. 525-542, 1982.
- 11) Zhang, J. and Dong, P.: Residual stresses in welded moment frames and implications for structural performance, *Journal of Structural Engineering, ASCE*, Vol. 126, No. 3, pp. 306-315, 2000.
- 12) Grondin, G. Y., Elwi, A. E. and Cheng, J. J. R.: Buckling of stiffened plates - a parametric study, *Journal of Constructional Steel Research*, Vol. 50, pp. 151-175, 1999.
- 13) Fujikubo, M. and Yao, T.: Elastic local buckling strength of stiffened plate considering plate/stiffener interaction and welding residual stress, *Marine Structures*, Vol. 12, pp. 543-564, 1999.
- 14) Banno, S., Usami, T. and Mizuno, E.: Cyclic elasto-plastic finite displacement analysis of plates with modified two-surface model, *Proceedings of the Japan Society of Civil Engineers, JSCE*, No. 525/1-33, pp. 1-15, 1995.
- 15) Hayashikawa, T., Matsui, Y. and Kaneko, T.: Nonlinear dynamic behavior and seismic isolation of steel towers of cable-stayed bridges under great earthquake ground motion, *Proceedings of 12th. World Conference on Earthquake Engineering*, Paper No. 0469, 2000.
- 16) Nakashima, M.: Strain-hardening behavior of shear panels made of low yield steel. I: test, *Journal of Structural Engineering, ASCE*, Vol. 121, No. 12, pp. 1742-1749, 1995.
- 17) Nakashima, M., Akazawa, T. and Tsuji, B.: Strain-hardening behavior of shear panels made of low yield steel. II: model, *Journal of Structural Engineering, ASCE*, Vol. 121, No. 12, pp. 1750-1757, 1995.
- 18) Nakashima, M., Iwai, S., Iwata, M., Takeuchi, T., Konomi, S., Akazawa, T. and Saburi, K.: Energy dissipation behavior of shear panels made of low yield steel, *Earthquake Engineering and Structural Dynamics*, Vol. 23, pp. 1299-1313, 1994.
- 19) Schafer, B. W. and Peköz, T.: Computational modeling of cold-formed steel: characterizing geometric imperfections and residual stresses, *Journal of Constructional Steel Research*, Vol. 47, pp. 193-210, 1998.
- 20) Chen, C. N.: Efficient and reliable solutions of static and dynamic nonlinear structural mechanics problems by an integrated numerical approach using DQFEM and direct time integration with accelerated equilibrium iteration schemes, *Applied Mathematical Modelling*, Vol. 24, pp. 637-655, 2000.
- 21) Ernst, J. H.: Der E-modul von seilen unter berucksichtigung des durchhanges, *Der Bauingenieur*, Berlin, Vol. 40, No. 2, 52-55, 1965 (in German).
- 22) Kikuchi, M., Dan, K. and Yoshiro, K.: Seismic behavior of a reinforced concrete building due to large vertical ground motion in near source regions, *Proceedings of 12th. World Conference on Earthquake Engineering*, Paper No. 1867, 2000.
- 23) Wilson, J. C. and Liu, T.: Ambient vibration measurements on a cable-stayed bridge, *Earthquake Engineering and Structural Dynamics*, Vol. 20, pp. 723-747, 1991.
- 24) Usami, T. and Ge, H. B.: Cyclic behavior of thin-walled steel structures - numerical analysis, *Thin-Walled Structures*, Vol. 32, pp. 41-80, 1998.
- 25) Grondin, G. Y., Elwi, A. E. and Cheng, J.J.R.: Buckling of stiffened steel plates - a parametric study, *Journal of Steel Constructional Steel Research*, Vol. 50, pp. 151-175, 1999.

(Received March 27, 2002)

## 斜張橋鋼製タワーの大地震時動的応答に関するパラメトリックスタディー

Shehata E. ABDEL RAHEEM・林川 俊郎

斜張橋鋼製タワーの動的応答性状に与える減衰特性, 入力地震動, 初期不整, エネルギー吸収機構およびタワーの骨組形状などの諸因子の影響を調べるためにパラメトリックスタディーが実施される。大地震動による斜張橋鋼製タワーの非線形動的応答解析には有限要素法が用いられる。タワー形状により水平梁の位置や長さによっては動的応答に好ましくない影響を与えることが数値計算で示される。また, 建設時における初期不整の影響が明らかにされる。質量比例型減衰は鋼製タワー基部に発生する軸力および加速度応答を過大評価することが判明した。